

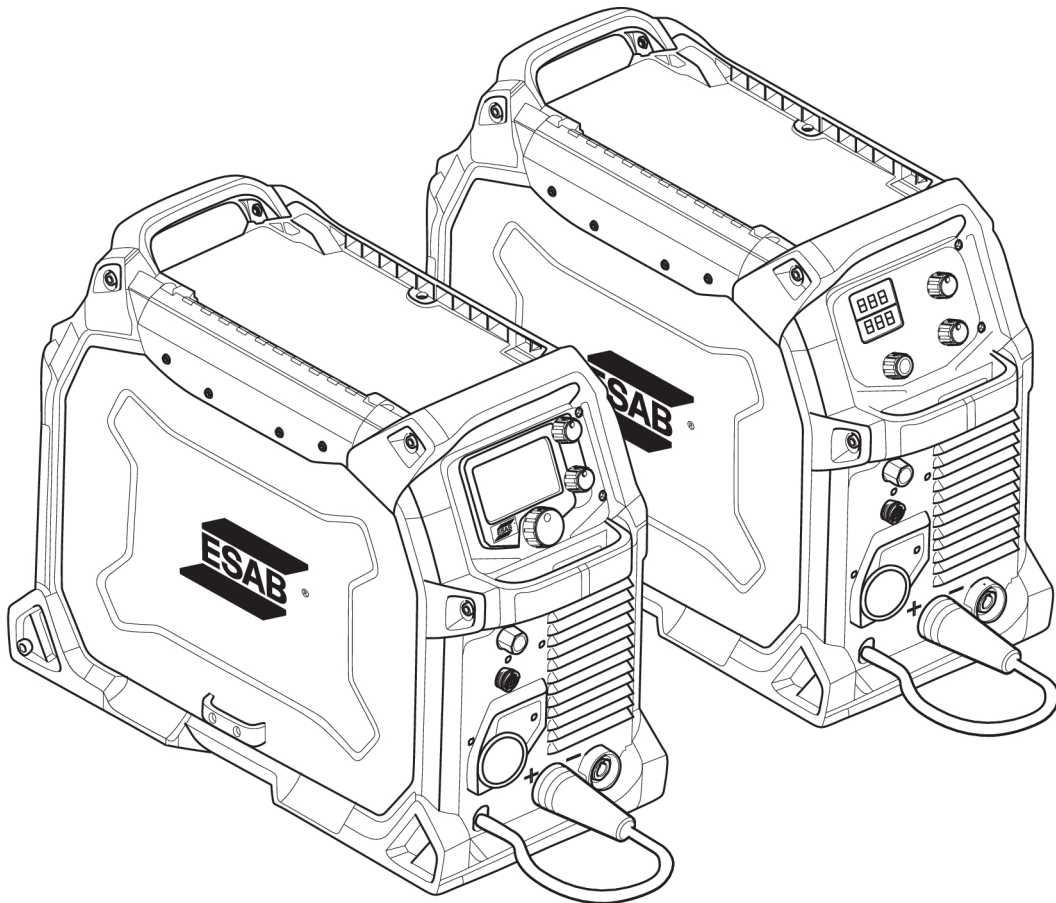

# *EMP 235ic, EM 235ic*



## **Instruction manual**

<b>1</b>	<b>SAFETY PRECAUTIONS</b> .....	<b>4</b>
1.1	Meaning of symbols .....	4
1.2	Safety guidance and information .....	4
1.3	User responsibility .....	9
<b>2</b>	<b>INTRODUCTION</b> .....	<b>11</b>
2.1	Equipment .....	11
<b>3</b>	<b>TECHNICAL DATA</b> .....	<b>13</b>
<b>4</b>	<b>INSTALLATION</b> .....	<b>16</b>
4.1	Location .....	16
4.2	Lifting instructions .....	16
4.3	Mains supply .....	17
4.3.1	Recommended fuse sizes and minimum cable area .....	17
4.3.2	Connecting the power source to input supply .....	18
<b>5</b>	<b>OPERATION</b> .....	<b>19</b>
5.1	Connections .....	20
5.2	Connecting welding and return cables .....	20
5.3	Polarity change .....	21
5.4	Inserting and replacing wire .....	21
5.5	Setting the wire feed pressure .....	23
5.6	Changing the feed/pressure rollers .....	23
5.7	Shielding gas .....	24
5.8	Volt-Ampere curves .....	25
5.9	Duty cycle .....	27
5.10	Overheating protection .....	29
<b>6</b>	<b>CONTROL PANEL</b> .....	<b>30</b>
6.1	How to navigate - EMP 235ic .....	30
6.1.1	Main menu .....	30
6.1.2	sMIG mode .....	30
6.1.3	Manual MIG mode .....	31
6.1.4	Flux cored wire mode .....	31
6.1.5	Stick mode .....	31
6.1.6	LIFT-TIG mode (EMP 235ic only) .....	32
6.1.7	Settings .....	32
6.1.8	User manual information .....	32
6.1.9	Icon reference guide .....	32
6.2	How to navigate - EM 235ic .....	35
6.2.1	Symbol reference EM 235ic .....	35
<b>7</b>	<b>MAINTENANCE</b> .....	<b>37</b>
7.1	Routine maintenance .....	37
7.2	Power source and wire feeder maintenance .....	37

TABLE OF CONTENTS

---

7.3	Torch and liner maintenance .....	38
8	TROUBLESHOOTING .....	39
9	ORDERING SPARE PARTS .....	41
	MIG WELD PARAMETER CHART .....	42
	FRACTION TO DECIMAL CONVERSION .....	44
	DIAGRAM .....	45
	ORDERING NUMBERS .....	46
	WEAR PARTS.....	47
	ACCESSORIES .....	49
	REPLACEMENTS PARTS.....	50

# 1 SAFETY PRECAUTIONS

## 1.1 Meaning of symbols

As used throughout this manual: Means Attention! Be Alert!



### DANGER!

Means immediate hazards which, if not avoided, will result in immediate, serious personal injury or loss of life.



### WARNING!

Means potential hazards which could result in personal injury or loss of life.



### CAUTION!

Means hazards which could result in minor personal injury.

## 1.2 Safety guidance and information



### WARNING!

Before use, read and understand the instruction manual and follow all labels, employer's safety practices and Safety Data Sheets (SDSs).



### WARNING!

These Safety Precautions are for your protection. They summarize precautionary information from the references listed in the Additional Safety Information section. Before performing any installation or operating procedures, be sure to read and follow the safety precautions listed below as well as all other manuals, material safety data sheets, labels, etc. Failure to observe Safety Precautions can result in injury or death.



### PROTECT YOURSELF AND OTHERS

Some welding, cutting and gouging processes are noisy and require hearing protection. The arc, like the sun, emits ultraviolet (UV) and other radiation and can injure the skin and eyes. Hot metal can cause burns. Training in the proper use of the processes and equipment is essential to prevent accidents. Therefore:

1. Wear a welding helmet fitted with a proper shade of filter to protect your face and eyes when welding or watching.
2. Always wear safety glasses with side shields in any work area, even if welding helmets, face shields and/or goggles are also required.
3. Use a face shield fitted with the correct filter and cover plates to protect your eyes, face, neck and ears from sparks and rays of the arc when operating or observing operations. Warn bystanders not to look at the arc and not to expose themselves to the rays of the electric-arc or hot metal.
4. Wear flameproof gauntlet-type gloves, heavy long-sleeve shirt, cuffless pants, high-topped shoes, and a welding helmet or cap for personal protection; in order to protect against arc rays and hot sparks or hot metal. A flameproof apron may also be desirable as additional protection against radiated heat and sparks.

5. Hot sparks or metal can lodge in rolled up sleeves, trouser cuffs, or pockets. Sleeves and collars should be kept buttoned (closed) and open pockets should be eliminated from the front of the clothing.
6. Protect other personnel from arc rays and hot sparks with a suitable non-flammable partition or curtains. Post warning signs advising others not to watch the welding arc or be in direct exposure to the active arc without proper protection.
7. Use goggles or face shields over safety glasses when chipping slag or grinding. Chipped slag may be hot and can fly for long distances. Bystanders should also wear goggles over safety glasses.



### **FIRES AND EXPLOSIONS**

**The heat from flames and arcs can start fires. Hot slag or sparks can also cause fires and explosions. Therefore:**

1. Protect yourself and others from flying sparks and hot metal.
2. Remove all combustible materials well away from the work area or cover the materials with an approved protective non-flammable covering. Combustible materials include wood, cloth, sawdust, liquid and gas fuels, solvents, paints, and coating paper, etc.
3. Hot sparks or hot metal can fall through cracks or crevices in floors or wall openings and cause a hidden smoldering fire or fires on the floor below. Make certain that such openings are protected from hot sparks and metal.
4. Follow the "hot work" procedures for the location. This can include a fire watch person who monitors the sparks during the work, the requirement for a formal work permit and the surveillance of the scene for an extended period of time to ensure no smoldering fires are developing.
5. Do not weld, cut, or perform other hot work until the work piece has been completely cleaned so that there are no substances on or in the work piece which might produce flammable or toxic vapors. Do not perform hot work on closed containers, they may explode.
6. Have fire extinguishing equipment handy for instant use, such as a garden hose, water pail, sand bucket, or portable fire extinguisher. Be sure you are trained in its use.
7. Do not use equipment beyond its ratings. For example, an overloaded welding cable can overheat and create a fire hazard.
8. After completing work, inspect the work area to make sure there are no hot sparks or hot metal that could cause a fire later. Use fire watchers when necessary.



### **ELECTRICAL SHOCK**

**Contact between live electrical parts and earth can cause severe injury or death. DO NOT use AC welding current in damp areas, if movement is confined, or if there is danger of falling. Therefore:**

1. Be sure the power source frame (chassis) is connected to the earth system of the input power. All ground points should be verified with periodic testing by an electrician.
2. Connect the workpiece to a good electrical earth.
3. Connect the work cable to the workpiece. A poor or missing connection can expose you or others to a fatal shock.
4. Use well-maintained equipment. Replace worn or damaged cables.
5. Keep everything dry, including clothing, work area, cables, torch/electrode holder and power source.
6. Make sure that all parts of your body are insulated from both the work piece and from the ground.

7. Do not stand directly on metal or the ground while working in tight quarters or a damp area; stand on an effective insulation layer, such as dry boards, an insulating platform, and wear rubber-soled shoes.
8. Put on dry, hole-free gloves before turning on the power.
9. Turn off the power, before removing your gloves.
10. Refer to ANSI/ASC Standard Z49.1 for specific grounding recommendations. Do not mistake the work lead for a earth cable.



### **ELECTRIC AND MAGNETIC FIELDS**

**May be dangerous. Electric current flowing through any conductor causes localized Electric and Magnetic Fields (EMF). Welding and cutting current creates EMF around welding cables and welding machines. Therefore:**

1. Welders with medical pacemakers fitted should consult their doctor before welding. EMF may interfere with some pacemakers.
2. Exposure to EMF may have other health effects which are unknown.
3. Welders should use the following procedures to minimize exposure to EMF:
  - a) Route the electrode and work cables together. Secure them with tape when possible.
  - b) Never coil the torch or work cable around your body.
  - c) Do not place your body between the torch and work cables. Route cables together on the same side of your body.
  - d) Connect the work cable to the workpiece as close as possible to the area being welded.
  - e) Keep the welding power source and cables as far away from your body as possible.



### **FUMES AND GASES**

**Fumes and gases, can cause discomfort or harm, particularly in confined spaces. Shielding gases can cause asphyxiation. Therefore:**

1. Keep your head out of the fumes, smoke, and vapors. Do not breathe the smoke, fumes, and gases that are generated by welding processes.
2. Always provide adequate ventilation in the work area by natural or mechanical means. Do not weld, cut or gouge on materials such as galvanized steel, stainless steel, copper, zinc, lead beryllium or cadmium unless positive mechanical ventilation is provided. Do not breathe in the fumes from these materials.
3. Orient the ventilation to draw smoke, fumes, and vapors in a direction away from the welding operator. Position ventilation suction to pull welding fumes and smoke from the far side of the work area if possible
4. Provide general ventilation for the surrounding work area if there is a risk of workers or other persons beyond the immediate work area getting exposed to significant welding fumes. Monitor the fugitive fumes and smoke for potential collateral exposures. Install appropriate ventilation controls or cease surrounding activity if fumes become an exposure issue outside of the immediate work area
5. Do not operate near degreasing and spraying operations. The heat or arc can react with chlorinated hydrocarbon vapors or liquids to form phosgene, a highly toxic gas, and other irritant gases.
6. If you develop momentary eye, nose or throat irritation while operating, this is an indication that the ventilation is not adequate. Stop work and take the necessary steps to improve ventilation in the work area. Do not continue to operate if physical discomfort persists.

7. Respiratory protection is required if worker respiratory exposures to fumes exceed recommended thresholds. Those thresholds can only be accurately measured through standardized industrial hygiene sampling protocols. Seek the assistance of specialists if your work causes respiratory exposures or you have other exposure concerns.
8. Refer to ANSI/ASC Standard Z49.1 for specific ventilation recommendations.
9. **WARNING:** This product when used for welding or cutting, typically produces fumes or gases which contain chemicals known to the State of California that can cause birth defects and in some cases cancer (California Health & Safety Code §25249.5 et seq.)



### **CYLINDER HANDLING**

**Cylinders, if mishandled, can rupture and violently release gas. A sudden rupture of the cylinder valve or relief device can injure or kill. Therefore:**

1. Locate cylinders away from heat, sparks and flames.
2. Inspect all connections before use to detect and correct any leaks or system defects. Use soapy water as a test if you suspect a leak but have difficulty confirming its location or existence.
3. Never strike an arc on a cylinder. Handle cylinders with care and avoid jolts and impacts to cylinders; regardless of if they are empty, partial, or full.
4. Secure all cylinders in a way that prevents them from falling and potentially doing damage to the valve, regulator, or attachments. Typically, this requires the use of a secure strap or chain at an appropriate height that helps to prevent the cylinder from falling over.
5. Use the proper gas for the process and use the proper pressure reducing regulator designed to operate from the compressed gas cylinder. Do not use adapters. Maintain hoses and fittings in good condition. Follow the manufacturer's operating instructions for mounting a regulator to a compressed gas cylinder.
6. Never secure cylinders to work tables or fixtures where they may become part of an electrical circuit.
7. When not in use, keep cylinder valves closed. Have valve protection cap in place if regulator is not connected. Secure and move cylinders by using suitable hand trucks.



### **MOVING PARTS**

**Moving parts, such as fans, rotors and belts can cause injury. Therefore:**

1. Keep all doors, panels, guards, and covers closed and securely in place.
2. Stop the engine or drive systems before installing or connecting a unit.
3. Have only qualified people remove covers for maintenance and troubleshooting as necessary
4. To prevent accidental starting of equipment during service, disconnect negative (-) battery cable from battery. Monitor the battery to prevent accidental reconnection before the work is done and the area is clear for restarting.
5. Keep hands, hair, loose clothing and tools away from moving parts. Do not use gloves near moving parts.
6. Reinstall panels or covers and close doors when service is finished and before starting engine.



**WARNING!**

**FALLING EQUIPMENT CAN INJURE**

- Only use lifting eye to lift unit. Do NOT use running gear, gas cylinders or any other accessories.
- Use equipment of adequate capacity to lift and support unit.
- If using lift forks to move unit, be sure forks are long enough to extend beyond opposite side of unit.
- Keep cables and cords away from moving vehicles and moving equipment when working from an aerial location.



**WARNING!**

**EQUIPMENT MAINTENANCE**

**Faulty or improperly maintained equipment can cause injury or death.**

**Therefore:**

1. Always have qualified personnel perform the installation, troubleshooting and maintenance work. Do not perform any electrical work unless you are qualified to perform such work.
2. Before performing any maintenance work inside a power source, disconnect the power source from the incoming electrical power.
3. Maintain cables, earthing wire, connections, power cord and power supply in safe working order. Do not operate any equipment in faulty condition.
4. Do not abuse any equipment or accessories. Keep equipment away from heat sources such as furnaces, wet conditions such as water puddles, oil or grease, corrosive atmospheres and inclement weather.
5. Keep all safety devices and cabinet covers in position and in good repair.
6. Use equipment only for its intended purpose. Do not modify it in any manner.



**CAUTION!**

**ADDITIONAL SAFETY INFORMATION**

**For more information on safe practices for electric arc welding and cutting equipment, ask your supplier for a copy of "Precautions and Safe Practices for Arc Welding, Cutting and Gouging." Form 52-529.**

The following publications are recommended to you:

1. ANSI/ASC Z49.1 - "Safety in Welding and Cutting"
2. AWS C5.5 - "Recommended Practices for Gas Tungsten Arc Welding"
3. AWS C5.6 - "Recommended Practices for Gas Metal Arc Welding"
4. AWS SP - "Safe Practices" - Reprint, Welding Handbook
5. ANSI/AWS F4.1 - "Recommended Safe Practices for Welding and Cutting of Containers That Have Held Hazardous Substances"
6. OSHA 29 CFR 1910 - "Safety and Health Standards"
7. CSA W117.2 - "Code for Safety in Welding and Cutting"
8. NFPA Standard 51B, "Fire Prevention During Welding, Cutting, and Other Hot Work"
9. CGA Standard P-1, "Precautions for Safe Handling of Compressed Gases in Cylinders"
10. ANSI Z87.1, "Occupational and Educational Personal Eye and Face Protection Devices"

### 1.3 User responsibility

Users of ESAB equipment have the ultimate responsibility for ensuring that anyone who works on or near the equipment observes all the relevant safety precautions. Safety precautions must meet or exceed the standard requirements that apply to this type of equipment. The following recommendations should be observed, in addition to the standard regulations that apply to the workplace.

All work must be carried out by trained personnel well-acquainted with the operation of the equipment. Incorrect operation of the equipment may lead to hazardous situations, which could result in injury to the operator and damage to the equipment.

1. Anyone who uses the equipment must be familiar with:
  - its operation
  - location of emergency stops and safety features
  - its function
  - the relevant safety precautions
  - welding and cutting methods or other applicable operations of the equipment
2. The operator must ensure that:
  - no unauthorized person is within the working area of the equipment when it is started up
  - no-one is unprotected when the arc is struck or work is started with the equipment
3. The workplace must:
  - be suitable for the purpose
  - be free from drafts to the extent possible, in order to maintain effective ventilation and the control of welding fumes and work byproducts
4. Personal safety equipment:
  - Always wear recommended personal safety equipment, such as safety glasses, flame-proof clothing, safety gloves
  - Do not wear loose-fitting items, such as scarves, bracelets, rings, etc., which could become trapped or cause burns
5. General precautions:
  - Make sure the return cable is connected securely
  - Work on high voltage equipment **may only be carried out by a qualified electrician**
  - Appropriate fire extinguishing equipment must be clearly marked and close at hand
  - Lubrication and maintenance must **not** be carried out on the equipment during operation

**WARNING!**

Arc welding and cutting may cause injury to yourself and others. Take precautions when welding and cutting. Ask for your employer's safety practices, which should be based on the manufacturer's hazard data.



**ELECTRIC SHOCK - Can kill**

- Install and ground the unit in accordance with applicable standards
- Do not touch live electrical parts or electrodes with bare skin, wet gloves, or wet clothing
- Insulate yourself from the ground and the workpiece
- Ensure your working position is safe



**FUMES AND GASES - Can be dangerous to your health**

- Keep your head out of the fumes
- Use ventilation, extraction at the arc, or both, to take fumes and gases away from your breathing zone and the general area



**ARC RAYS - Can injure eyes and burn skin**

- Protect your eyes and body. Use the correct welding darkening screen and filter lens, and wear protective clothing
- Protect bystanders with suitable screens or curtains



**FIRE HAZARD**

- Sparks (spatter) can cause a fire. Therefore, make sure that there are no flammable/combustible materials nearby
- Take steps to monitor the work area for fugitive sparks that could cause a fire, either immediately or after smoldering over time



**NOISE - Excessive noise can damage hearing**

Protect your ears. Use earmuffs or other hearing protection with the appropriate level of noise reduction/hearing protection.

**MALFUNCTION** - Call for expert assistance in the event of malfunction.

**PROTECT YOURSELF AND OTHERS!**



**WARNING!**

Do not use the power source for thawing frozen pipes.



**CAUTION!**

This product is solely intended for arc welding.

**ESAB has an assortment of welding accessories and personal protection equipment for purchase. For ordering information, contact your local ESAB dealer or visit us on our website.**

## 2 INTRODUCTION

---

The ESAB EM and EMP product family is a new generation of MIG and multi-process (MIG/Stick/TIG) welding power sources.

All Rebel power sources are designed to match the needs of the user. They are tough, durable and portable, providing excellent arc performance across a variety of welding applications.

The EMP features a 4.3 in. (11.0 cm) color TFT user interface display which provides quick and easy selection of weld process and parameters, suitable for both newly trained and intermediate level users. For more advanced users a number of functions could be introduced and customized to give maximum flexibility.

Exclusive to ESAB, sMIG provides users with excellent short circuit transfer arc characteristics.

The EM and EMP family connects to 120 V – 230 V, 1 ~ 50/60 Hz input power supplies, supplied by mains or generator power. Incorporating a PFC (Power Factor Correction) circuit significantly increases power efficiency.

Key features:

- Excellent MIG characteristics (EM)
- Excellent multi-process, MIG/Stick and Lift/TIG (EMP) welding capabilities
- Automatic recognition of input power with PFC (120 V – 230 V)
- Large 4.3 in. (11 cm) high resolution customizable user interface (EMP)
- Rugged case design and internal hardware
- Portable
- High grade cast aluminum wire drive system provides excellent control of drive roll geometry ensuring smooth, precise wire feeding
- Professional high grade accessories

### 2.1 Equipment

Package consists of the following:

#### EMP series

- ESAB EMP 235ic power source
- Tweco® Spray Master 250 A MIG gun with 15.0 ft (4.6 m) cable, 0.030 in., 0.035 in., 0.045 in. (0.8 mm, 0.9 mm, 1.2 mm) contact tips and Allen key
- Tweco® Classic Velocity™ No. 2 with 15.0 ft (4.6 m) cable (for 0558012702 MX)
- Adapter cable 4 pin to 8 pin (for 0558012702 MX)
- ESAB stick electrode holder, 12 ft (4 m), 200 A
- Ground clamp, 10 ft (3 m), 250 A
- Input cable 10 ft (3 m) with 230 V plug (part of power source)
- Power adapter cable (230 V to 120 V, 15 A)
- Victor® Flow Meter with 10 ft (3 m) gas hose
- ESAB OK AristoRod™ premium solid wire 0.035 in. (0.9 mm) 11# spool
- ESAB Atom Arc Acclaim 1/8 in. premium stick electrodes 1# sample pack
- Drive roll, 0.023 in. / 0.030 in. / 0.035 in. / 0.045 in. (0.6 mm / 0.8 mm / 0.9 mm / 1.2 mm)
- Guide tubes 0.023 in. – 0.045 in. (0.6 mm – 1.2 mm)
- Thickness gauge tool
- USB stick including manuals
- Safety manual
- Quick start guide

**EM series**

- ESAB EM 235ic power source
- Tweco® Spray Master 250 A MIG gun with 15 ft (4.6 m) cable, 0.030 in., 0.035 in., 0.045 in. (0.8 mm, 0.9 mm, 1.2 mm) contact tips and Allen Key
- Tweco® Classic Velocity™ No. 2 with 15.0 ft (4.6 m) cable (for 0558012700 MX)
- Adapter cable 4 pin to 8 pin (for 0558012700 MX)
- Ground clamp, 10 ft (3 m), 250 A
- Input cable 10 ft (3 m) with 230 V plug (part of power source)
- Power adapter cable (230 V to 120 V, 15 A)
- Victor® Flow Meter with 10 ft (3 m) gas hose
- ESAB OK AristoRod™ premium solid wire 0.035 in. (0.9 mm) 11# spool
- ESAB Atom Arc Acclaim 1/8 in. premium stick electrodes 1# sample pack
- Guide tubes 0.023 in. – 0.045 in. (0.6 mm – 1.2 mm)
- Thickness gauge tool
- USB stick including manuals
- Safety manual
- Quick start guide

### 3 TECHNICAL DATA

	<b>EMP 235ic</b>	
<b>Voltage</b>	230 V, 1 ~ 50/60 Hz	120 V, 1 ~ 50/60 Hz
<b>Primary current</b>		
$I_{\max}$ . GMAW - MIG	32.1 A	Breaker 20 A: 28.6 A Breaker 15 A: 20.3 A
$I_{\max}$ . GTAW - TIG	26.1 A	Breaker 15 A: 20.8 A
$I_{\max}$ . SMAW - Stick	31.3 A	Breaker 15 A: 20.8 A
$I_{\text{eff}}$ . GMAW - MIG	20.31 A	Breaker 20 A: 18.0 A Breaker 15 A: 14.6 A
$I_{\text{eff}}$ . GTAW - TIG	19.8 A	Breaker 15 A: 14.7 A
$I_{\text{eff}}$ . SMAW - Stick	16.5 A	Breaker 15 A: 14.7 A
<b>Permissible load at GMAW - MIG</b>		
100% duty cycle	160 A / 22.0 V	Breaker 15 A: 75 A / 17.75 V Breaker 20 A: 90 A / 18.5 V
60% duty cycle	200 A / 24.0 V	Breaker 15 A: 90 A / 18.5 V Breaker 20 A: 110 A / 19.5 V
40% duty cycle	235 A / 25.75 V	Breaker 15 A: 100 A / 19 V
20% duty cycle	–	Breaker 20 A: 130 A / 20.5 V
<b>Setting range (DC)</b>	15 A / 14.75 V – 250 A / 30.0 V	15 A / 14.75 V – 130 A / 20.5 V
<b>Permissible load at GTAW - TIG</b>		
100% duty cycle	170 A / 16.8 V	100 A / 14 V
60% duty cycle	215 A / 18.6 V	120 A / 14.8 V
40% duty cycle	–	130 A / 15.2 V
30% duty cycle	240 A / 19.6 V	–
<b>Setting range (DC)</b>	5 A / 10.2 V – 240 A / 19.6 V	5 A / 10.2 V – 200 A / 18.0 V
<b>Permissible load at SMAW - Stick</b>		
100% duty cycle	130 A / 25.2 V	65 A / 22.6 V
60% duty cycle	170 A / 26.8 V	80 A / 23.2 V
40% duty cycle	–	85 A / 23.4 V
25% duty cycle	210 A / 28.4 V	–
<b>Setting range (DC)</b>	16 A / 20.6 V – 210 A / 28.4 V	16 A / 20.6 V – 130 A / 25.2 V
<b>Open circuit voltage (OCV)</b>		
VRD deactivated	68 V	68 V
VRD activated	35 V	35 V
<b>Idle power</b>	24 W	24 W
<b>Efficiency</b>	84 %	84%
<b>Power factor</b>	0.98	0.99

	<b>EMP 235ic</b>	
<b>Wire feed speed</b>	80–700 in./min (2.0–17.89 m/min)	80–700 in./min (2.0–17.89 m/min)
<b>Wire diameter</b>		
Mild steel solid wire	0.023–0.045 in. (0.6–1.2 mm)	0.023–0.045 in. (0.6–1.2 mm)
Stainless steel solid wire	0.030–0.045 in. (0.8–1.2 mm)	0.030–0.045 in. (0.8–1.2 mm)
Flux cored wire	0.030–0.052 in. (0.8–1.3 mm)	0.030–0.052 in. (0.8–1.3 mm)
Aluminum	0.030–0.045 in. (0.8–1.2 mm)	0.030–0.045 in. (0.8–1.2 mm)
<b>Bobbin size</b>	Ø 4–12 in. (100–300 mm)	Ø 4–12 in. (100–300 mm)
<b>Dimensions l×w×h</b>	27.0 × 11.5 × 19.5 in. (686 × 292 × 495 mm)	27.0 × 11.5 × 19.5 in. (686 × 292 × 495 mm)
<b>Weight</b>	63 lb (28.6 kg)	63 lb (28.6 kg)
<b>Operating temperature</b>	14 to 104 °F (-10 to +40 °C)	14 to 104 °F (-10 to +40 °C)
<b>Enclosure class</b>	IP23S	IP23S
<b>Application classification</b>	<b>S</b>	<b>S</b>

	<b>EM 235ic</b>	
<b>Voltage</b>	230 V, 1 ~ 50/60 Hz	120 V, 1 ~ 50/60 Hz
<b>Primary current</b>		
$I_{max}$ . GMAW - MIG	32.1 A	Breaker 20 A: 28.6 A Breaker 15 A: 20.3 A
$I_{eff}$ . GMAW - MIG	20.31 A	Breaker 15 A: 14.6 A Breaker 20 A: 18.0 A
<b>Permissible load at GMAW - MIG</b>		
100% duty cycle	160 A / 22.0 V	Breaker 15 A: 75 A / 17.75 V Breaker 20 A: 90 A / 18.5 V
60% duty cycle	200 A / 24.0 V	Breaker 15 A: 90 A / 18.5 V Breaker 20 A: 110 A / 19.5 V
40% duty cycle	235 A / 25.75 V	Breaker 15 A: 100 A / 19 V
20% duty cycle	–	Breaker 20 A: 130 A / 20.5 V
<b>Setting range (DC)</b>	15 A / 14.75 V – 250 A / 30.0 V	15 A / 14.75 V – 130 A / 20.5 V
<b>Open circuit voltage (OCV)</b>		
VRD deactivated	68 V	68 V
VRD activated	35 V	35 V
<b>Efficiency</b>	84%	84%
<b>Power factor</b>	0.98	0.99
<b>Wire feed speed</b>	60–700 in./min (1.5–17.89 m/min)	60–700 in./min (1.5–17.89 m/min)
<b>Wire diameter</b>		
Mild steel solid wire	0.023–0.045 in. (0.6–1.2 mm)	0.023–0.045 in. (0.6–1.2 mm)
Stainless steel solid wire	0.030–0.045 in. (0.8–1.2 mm)	0.030–0.045 in. (0.8–1.2 mm)

	<b>EM 235ic</b>	
Flux cored wire	0.030–0.052 in. (0.8–1.3 mm)	0.030–0.052 in. (0.8–1.3 mm)
Aluminum	0.030–0.045 in. (0.8–1.2 mm)	0.030–0.045 in. (0.8–1.2 mm)
<b>Bobbin size</b>	Ø 4–12 in. (100–300 mm)	Ø 4–12 in. (100–300 mm)
<b>Dimensions l×w×h</b>	27.0 × 11.5 × 19.5 in. (686 × 292 × 495 mm)	27.0 × 11.5 × 19.5 in. (686 × 292 × 495 mm)
<b>Weight</b>	63 lb (28.6 kg)	63 lb (28.6 kg)
<b>Operating temperature</b>	14 to 104 °F (-10 to +40 °C)	14 to 104 °F (-10 to +40 °C)
<b>Enclosure class</b>	IP23S	IP23S
<b>Application classification</b>	<b>S</b>	<b>S</b>

### Duty cycle

The duty cycle refers to the time as a percentage of a ten-minute period that you can weld at a certain current without overheating. The duty cycle is valid for 104 °F / 40 °C.

For more information, see section "Duty cycle" in chapter OPERATION.

### Enclosure class

The **IP** code indicates the enclosure class, i.e. the degree of protection against penetration by solid objects or water.

Equipment marked **IP 23S** is intended for indoor and outdoor use; however, should not be operated in precipitation.

### Application class

The symbol **S** indicates that the power source is designed for use in areas with increased electrical hazard.

## 4 INSTALLATION

The installation must be carried out by a professional.



### CAUTION!

This product is intended for industrial use. In a domestic environment, this product may cause radio interference. It is the user's responsibility to take adequate precautions.

### 4.1 Location

Position the power source so that its cooling air inlets and outlets are not obstructed.

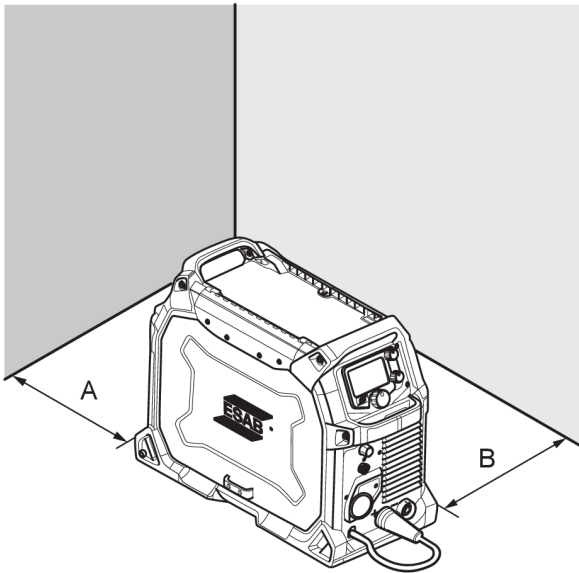

A. 4 in. (100 mm)

B. 4 in. (100 mm)

### 4.2 Lifting instructions

The power source can be lifted using any of the handles.

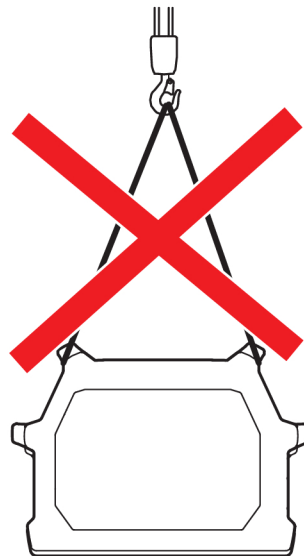
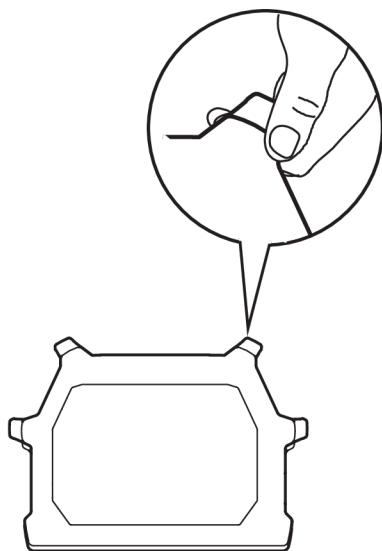

Secure the equipment - particularly if the ground is uneven or sloping.

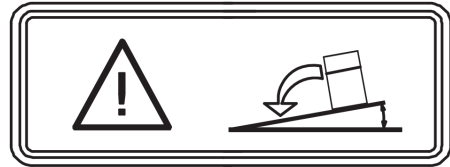

### 4.3 Mains supply

The supply voltage should be 230 V AC  $\pm 10\%$  or 120 V  $\pm 10\%$ . Too low supply voltage may cause poor welding performance. Too high of welding supply voltage will cause components to overheat and possibly fail. Contact the local electric utility for information about the type of electrical service available, how proper connections should be made, and inspection required.

The Welding power source must be:

- Correctly installed, if necessary, by a qualified electrician.
- Correctly grounded (electrically) in accordance with local regulations.
- Connected to the correct size power point and fuse as indicated in table below.



#### WARNING!

Do not connect an input (WHITE or BLACK) conductor to the ground terminal.  
Do not connect the ground (GREEN) conductor to an input line terminal.



#### NOTE!

Use the welding power source in accordance with the relevant national regulations.



#### CAUTION!

Disconnect input power and secure employing 'Lock-out' / 'Tagging' procedures. Ensure input power line disconnect switch is locked (lock-out/Tagging) in the 'Open' position BEFORE removing input power fuses. Connection/Disconnect should be carried out by competent persons.

Rating plate with supply connection data

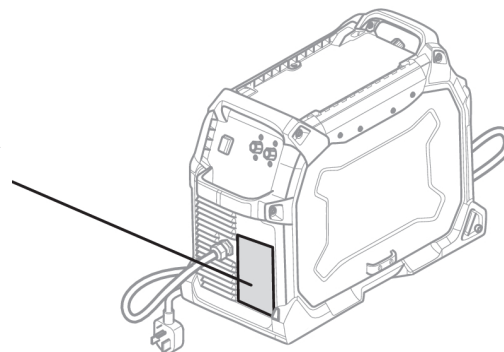

#### 4.3.1 Recommended fuse sizes and minimum cable area



#### WARNING!

An electrical shock or fire hazard is probable if the following electrical service guide recommendations are not followed. These recommendations are for a dedicated branch circuit sized for the rated output and duty cycle of the welding power source.

	120 – 230 V, 1 ~ 50/60 Hz	
Supply voltage	230 V AC	120 V AC
Input current at maximum output	48 A	30 A
Maximum recommended fuse* or circuit breaker rating *Time delay fuse UL class RK5, refer to UL 248	40 A	30 A
Maximum recommended fuse* or circuit breaker rating *Normal operating UL class K5, refer to UL 248	50 A	50 A
Minimum recommended cord size	10 AWG (5.3 mm <sup>2</sup> )	12 AWG (4 mm <sup>2</sup> )
Maximum recommended extension cord length	50 ft (15 m)	25 ft (8 m)
Minimum recommended grounding conductor size	10 AWG (5.3 mm <sup>2</sup> )	12 AWG (4 mm <sup>2</sup> )

### Supply from power generators

The power source can be supplied from different types of generators. However, some generators may not provide sufficient power for the welding power source to operate correctly. Generators with Automatic Voltage Regulation (AVR) or with equivalent or better type of regulation, with 10 kW rated power, are recommended.

### 4.3.2 Connecting the power source to input supply

Use one of the supplied adapters to connect the power source to mains.

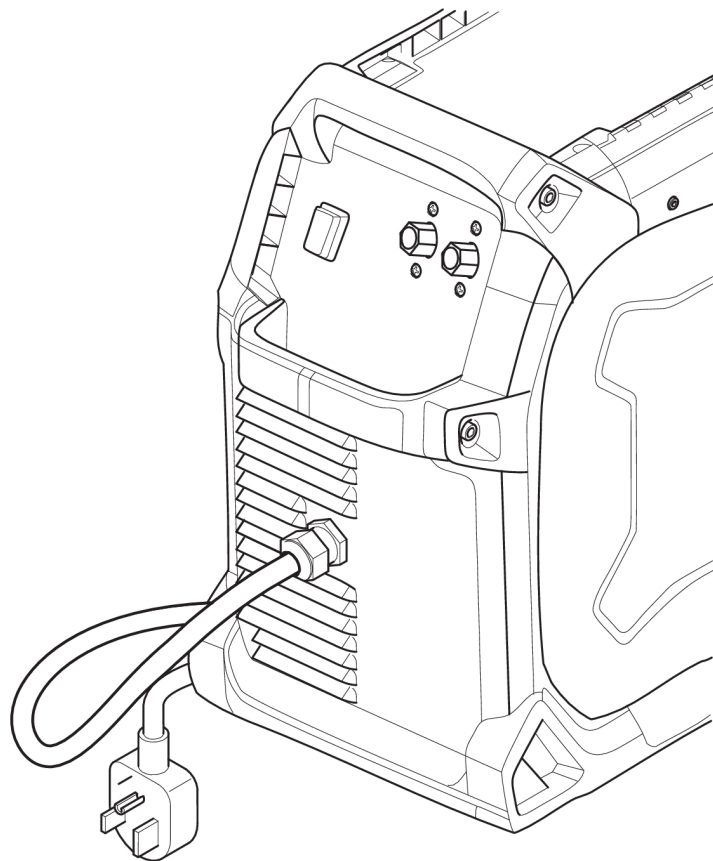
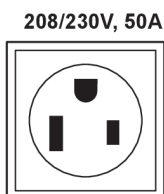
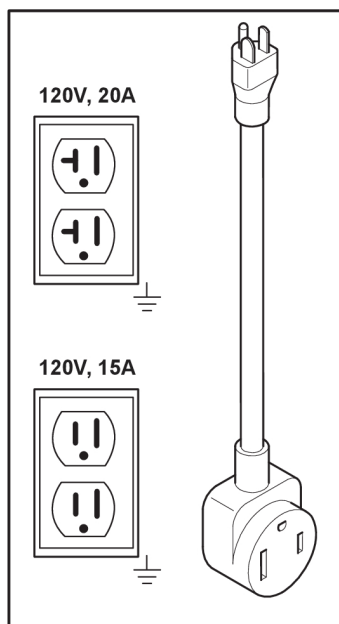

NEMA 6-50P 230VAC plug

## 5 OPERATION

General safety regulations for handling the equipment can be found in the "SAFETY PRECAUTIONS" chapter of this manual. Read it through before you start using the equipment!

**NOTE!**

When moving the equipment, use the intended handle. Never pull on the cables.

**WARNING!**

Rotating parts can cause injury, take great care.

**WARNING!**

Electric shock! Do not touch the workpiece or the welding head during operation!

**WARNING!**

Make sure that the side covers are closed during operation.

**WARNING!**

Ensure spool retaining cotter pin is in place to prevent the spool from sliding off the hub.

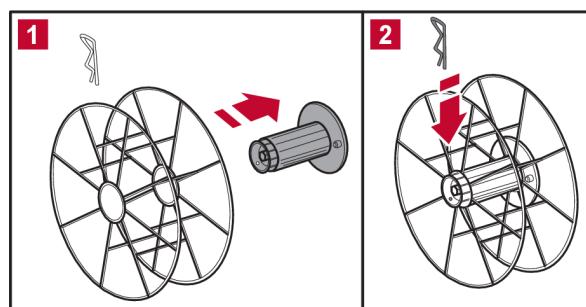

## 5.1 Connections

Front and rear:

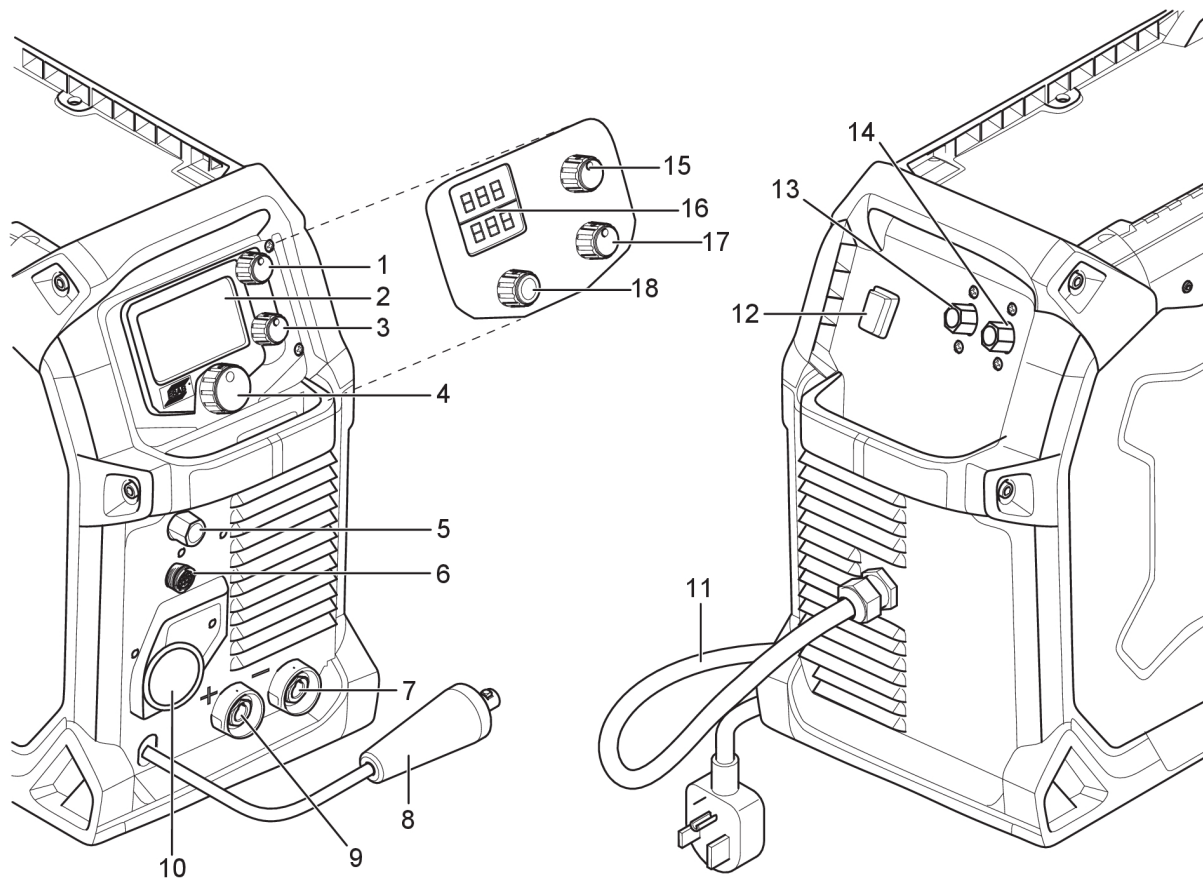

- |  |                                       |
|--|---------------------------------------|
| 1. Knob for current or wire feed speed selection (EMP) | 10. Torch connection                  |
| 2. Display (EMP)                                       | 11. Mains cable                       |
| 3. Knob for voltage selection (EMP)                    | 12. Mains supply switch ON/OFF        |
| 4. Main knob for menu navigation (EMP)                 | 13. Gas valve inlet for TIG/Spool-gun |
| 5. Gas valve output for TIG/Spool-gun                  | 14. Gas valve inlet for MIG/MAG       |
| 6. Torch/Remote control connection                     | 15. Knob for voltage selection (EM)   |
| 7. Negative output [-]                                 | 16. Display LED - Volt/Ampere (EM)    |
| 8. Polarity changeover cable                           | 17. Knob for wire feed (EM)           |
| 9. Positive output [+]                                 | 18. Knob for process selection (EM)   |

## 5.2 Connecting welding and return cables

The power source has two outputs for connecting welding and return cables: A negative [-] terminal (7) and a positive [+] terminal (9); see front illustration.

For the TIG process, connect the TIG torch trigger remote or foot control to the remote receptacle (6); see front illustration. Connect the TIG torch gas connector to the gas outlet receptacle (5). Connect gas input supply from a regulated shielding gas supply to the gas inlet connector (13) located on the rear of the machine.

For MIG/Stick process the output to which the welding cable is connected depends on the type of electrode, refer to electrode packaging for information relating to the correct electrode polarity. Connect the return cable to the remaining welding terminal on the power source.

Secure the return cable's contact clamp to the workpiece and ensure that there is good contact.

### 5.3 Polarity change

The power source is delivered with the polarity changeover cable connected to the positive terminal. Some wires, e.g. self-shielded cored wires, are recommended to be welded with negative polarity. Negative polarity means that the polarity changeover cable is connected to the negative terminal and the return cable to the positive terminal. Check the recommended polarity for the welding wire you want to use.

The polarity can be changed by moving the polarity changeover cable to suit the applicable welding process.

#### Drive system diagram

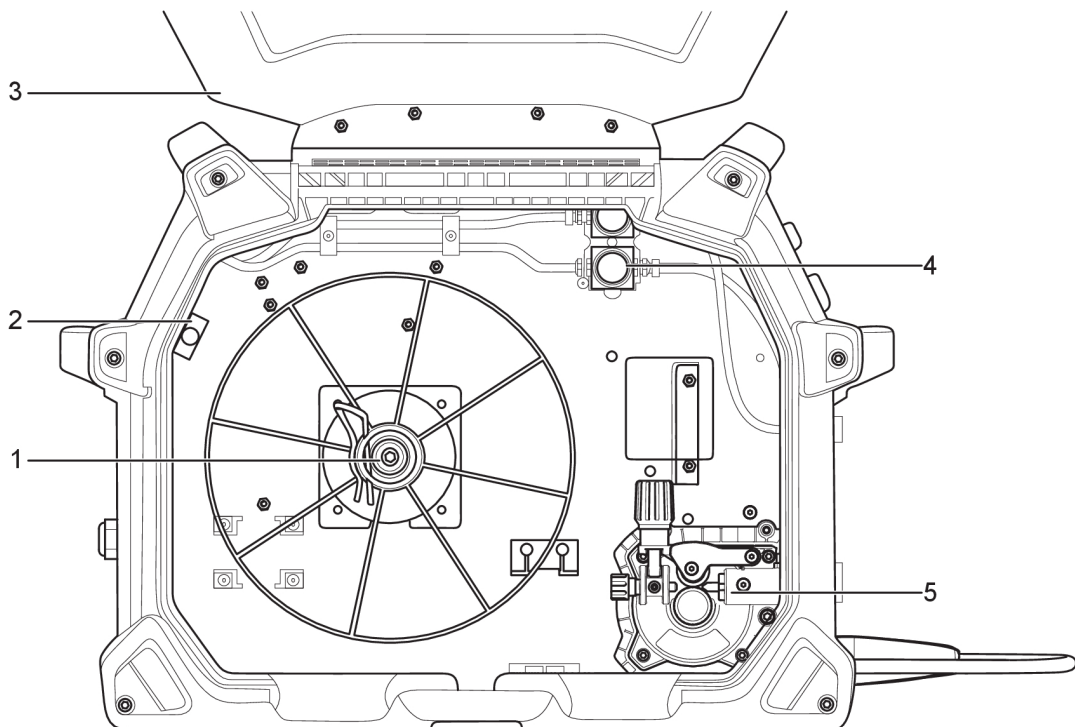

- |                       |                        |
|-----------------------|------------------------|
| 1. Spool hub          | 4. Gas valves          |
| 2. Circuit breaker    | 5. Wire feed mechanism |
| 3. Opening side cover |                        |

### 5.4 Inserting and replacing wire

EMP 235ic and EM 235ic will handle bobbin sizes of 4 in. (100 mm), 8 in. (200 mm) and 12 in. (300 mm). See TECHNICAL DATA chapter for suitable wire dimensions for each wire type.



#### WARNING!

Do not place or point the torch near the face, hand, or body as this may result in personal injury.



#### WARNING!

Risk of crushing or pinching when replacing the wire spool! Do **not** use safety gloves when inserting the welding wire between the feed rollers.

**NOTE!**

Make sure the correct feed/pressure rollers are used. For more information see appendix WEAR PARTS.

**NOTE!**

Remember to use the correct contact tip in the welding torch for the wire diameter used. The torch is fitted with a contact tip for 0.030 in. (0.8 mm) wire. If you use another diameter you must change the contact tip and drive roll. The wire liner fitted in the torch is recommended for welding with Fe and SS wires.

1. Open the side cover.
2. Release the pressure roller arm by pushing the tension screw toward you (1).
3. Lift the pressure roller arm up (2).
4. With the MIG welding wire feeding from the bottom of the spool pass the electrode wire through the inlet guide (3), between the rollers, through the outlet guide and into the MIG torch.
5. Re-secure the pressure roller arm and wire drive tension screw and adjust the pressure if necessary. Remove the velocity nozzle and contact tip from the MIG torch.
6. With the MIG torch lead reasonably straight, feed the wire through the MIG torch by depressing the trigger switch. Fit the appropriate velocity nozzle and contact tip.
7. Close the side cover.

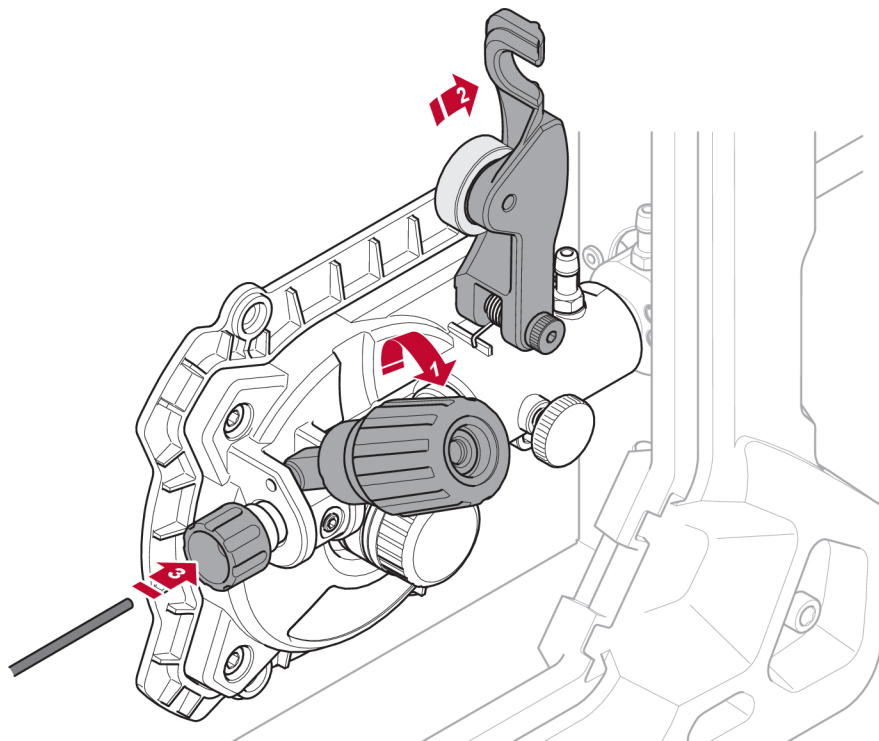

### Welding with aluminium wire

In order to weld with aluminium wire use optional Spool gun. Refer to Instruction manual for Spool gun for set up.

## 5.5 Setting the wire feed pressure

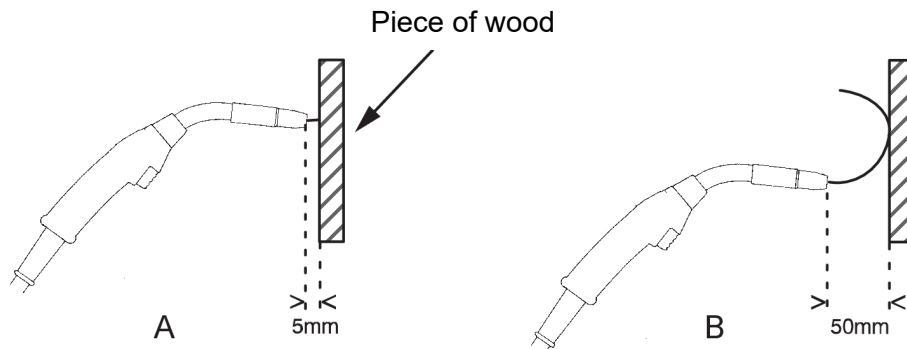

Start by making sure that the wire moves smoothly through the wire guide. Then set the pressure of the wire feeder's pressure rollers. It is important that the pressure is not too high.

To check that the feed pressure is set correctly, you can feed out the wire against an insulated object, e.g. a piece of wood.

When you hold the welding torch approximately  $\frac{1}{4}$  in. (6 mm) from the piece of wood (Illustration A) the feed rollers should slip.

If you hold the welding torch approximately 2 in. (50 mm) from the piece of wood, the wire should be fed out and bend (Illustration B).

## 5.6 Changing the feed/pressure rollers

Three dual groove feed rollers are supplied as standard. Change the feed roller to match the filler metal.



### NOTE!

Be sure not to lose the key that is located on the drive motor shaft. This key must align with drive roll groove for proper operation.

1. Open the side cover.
2. Remove the feed roll retaining screw by turning it in a counter-clockwise direction.
3. Change the feed roll.
4. Tighten the feed roll retaining screw by turning it to clockwise position.
5. Close the side cover.

**NOTE!**

The visual wire stamp designates the wire diameter groove in use.

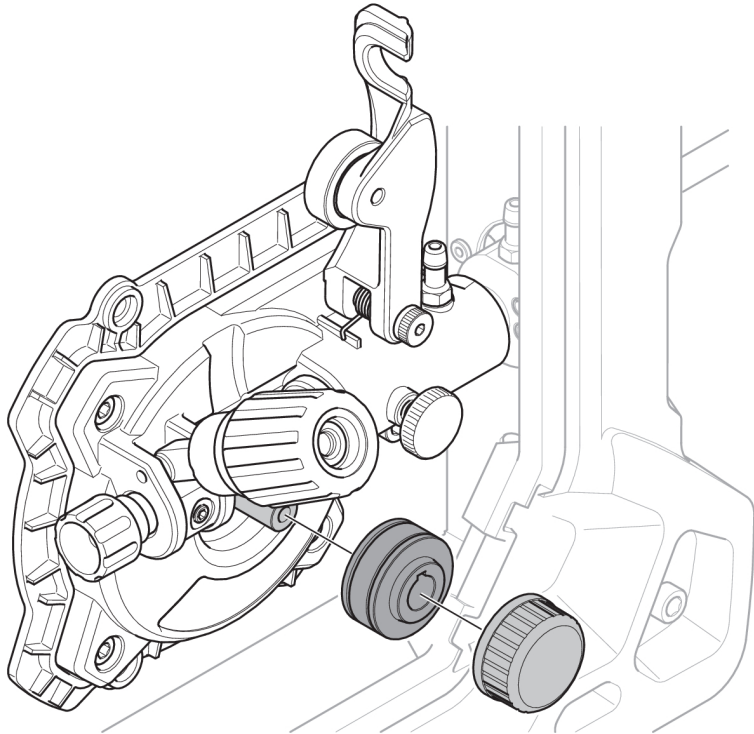
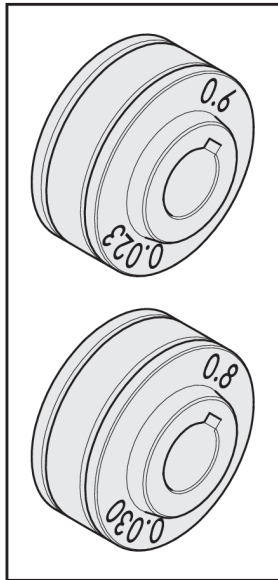

## 5.7 Shielding gas

The choice of suitable shielding gas depends on the material. Typically mild steel is welded with mixed gas (Ar + CO<sub>2</sub>) or 100% carbon dioxide (CO<sub>2</sub>). Stainless Steel can be welded with mixed gas (Ar + CO<sub>2</sub>) or Trimix (He + Ar + CO<sub>2</sub>). Aluminum and silicon bronze use pure argon gas (Ar). In the sMIG mode (see section "sMIG mode" in the CONTROL PANEL chapter) the optimal welding arc with the gas you use will be automatically set.

## 5.8 Volt-Ampere curves

The curves below show the maximum voltage and amperage output capabilities of the power source for three common welding process settings. Other settings result in curves that fall between these curves.

A=Welding current (AMPS), V=Output voltage

**SMAW (Stick) 230 V**

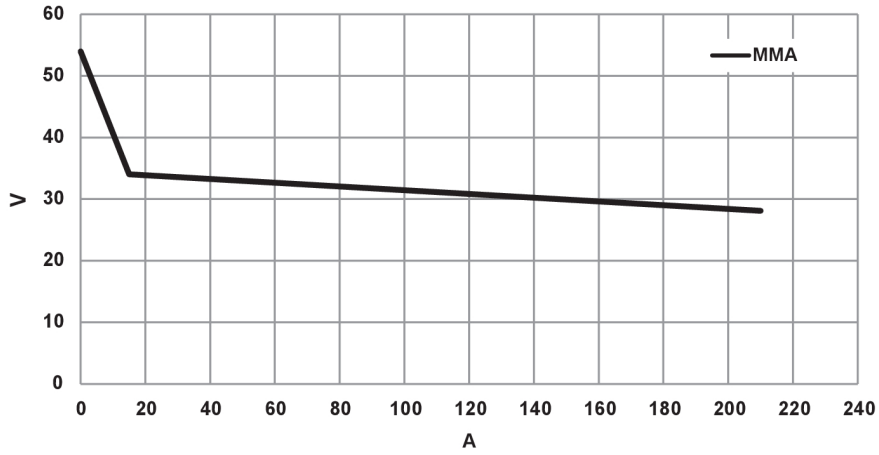

**SMAW (Stick) 120 V**

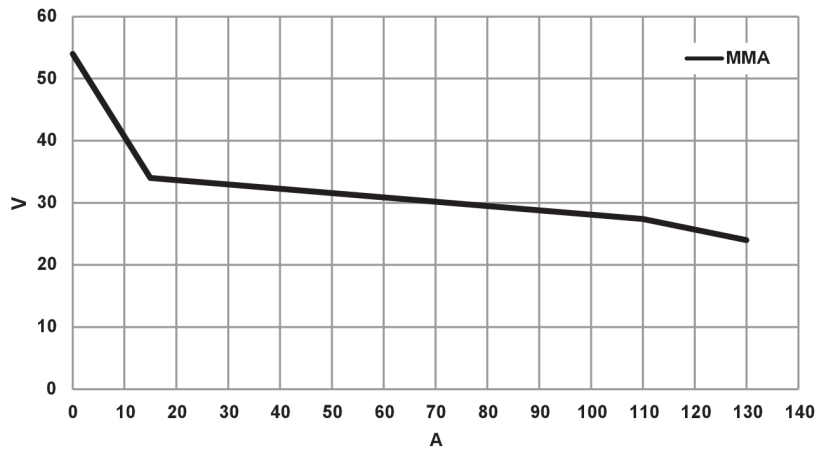

### GMAW (MIG) 230 V

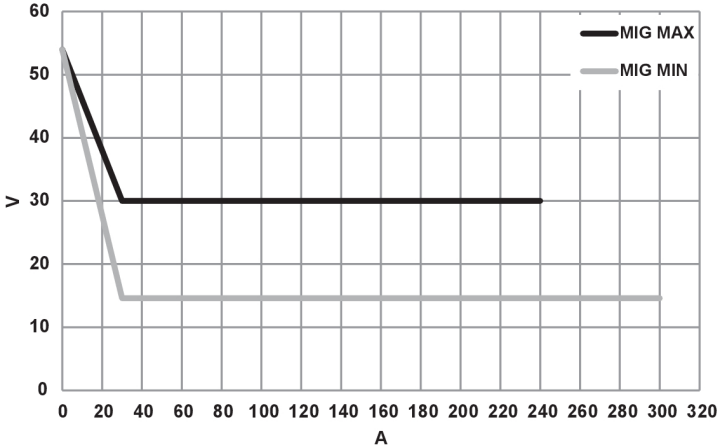

### GMAW (MIG) 120 V

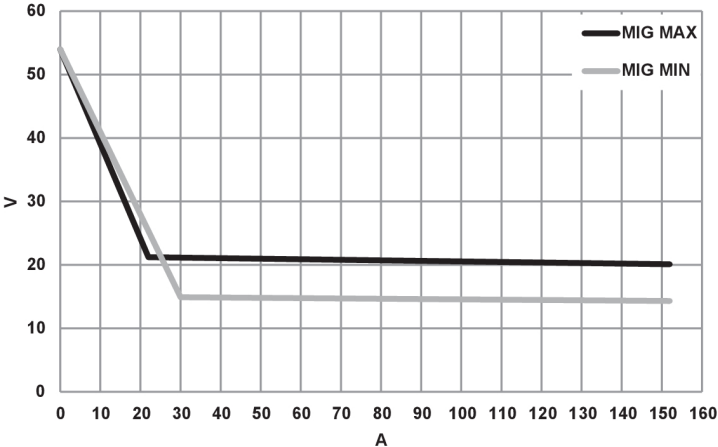

GTAW (TIG) 230 V

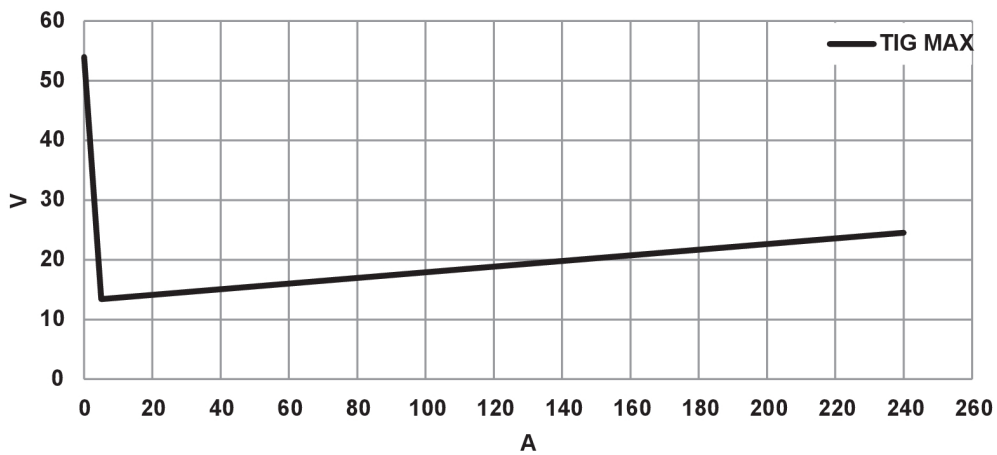

GTAW (TIG) 120 V

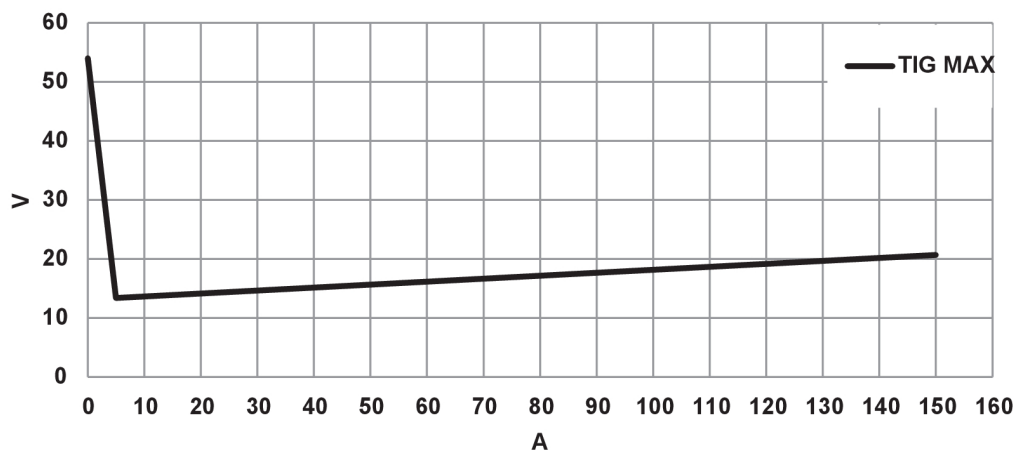

## 5.9 Duty cycle

The EMP 235ic and EM 235ic both have a welding current output of 235 A at 40% duty cycle (230 V). A self-resetting thermostat will protect the power source if the duty cycle is exceeded.

**Example:** If the power source operates at a 40% duty cycle, it will provide the rated amperage for a maximum of 4 minutes out of every 10 minute period. The remaining time, 6 minutes, the power source must be allowed to cool down.

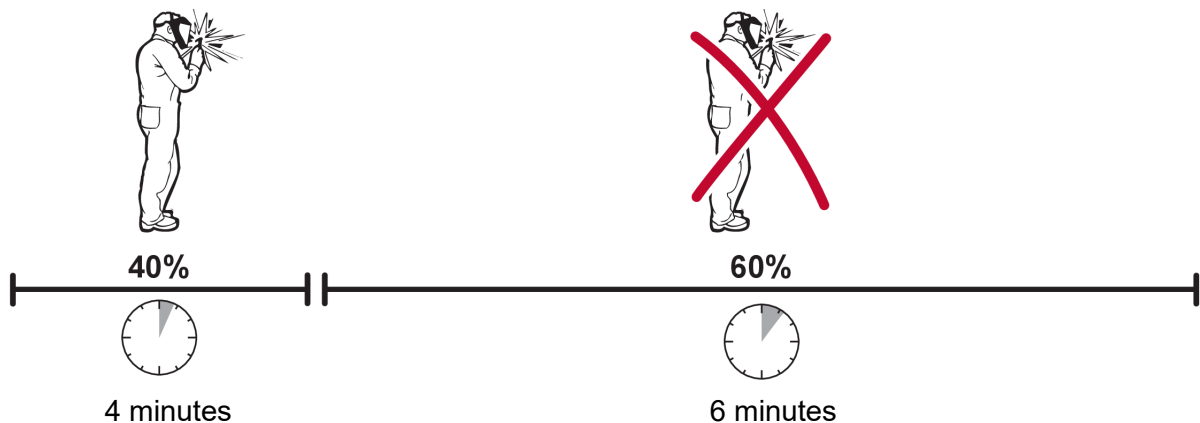

A different combination of duty cycle and welding current can be selected. Use the graphs below to determine the correct duty cycle for a given welding current.

### Duty cycle on 120 V AC

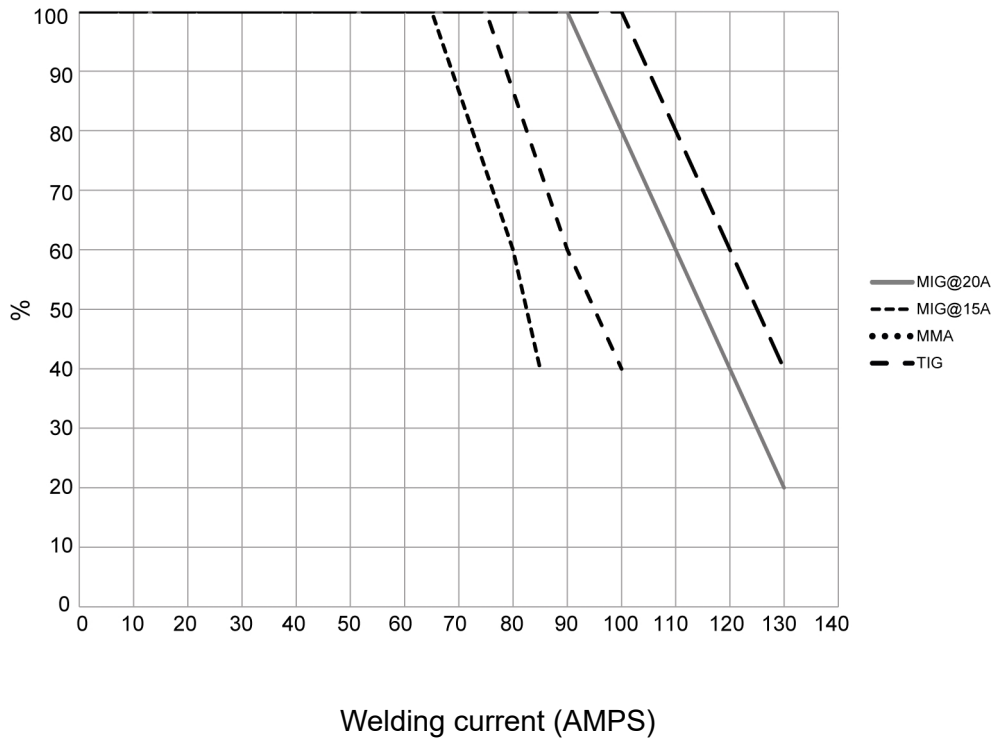

### Duty cycle on 230 V AC

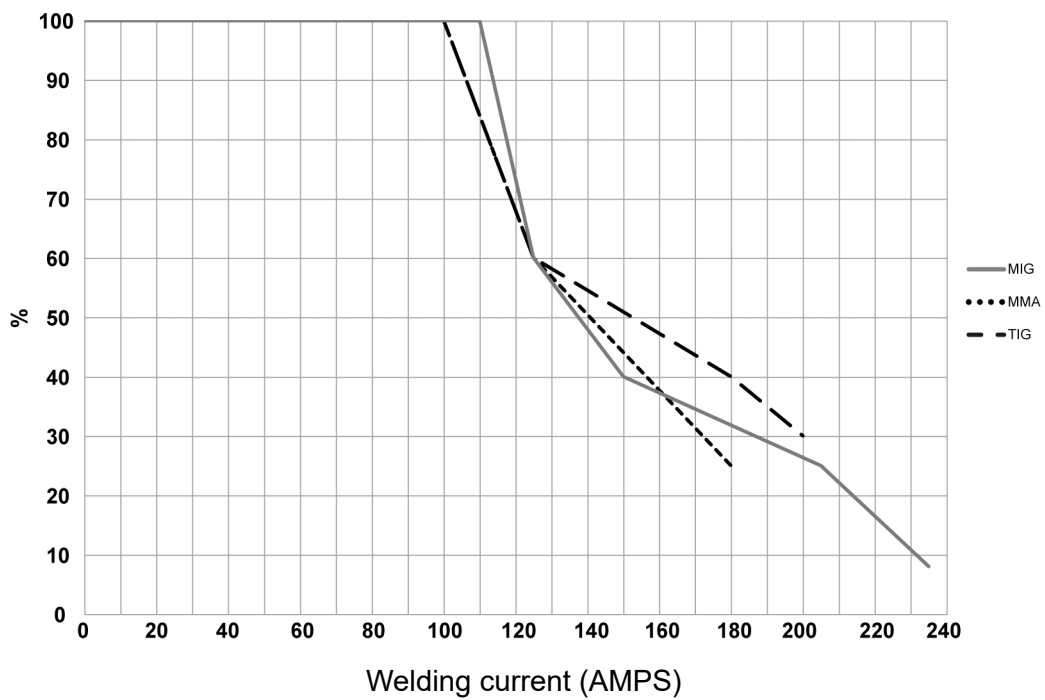

## 5.10 Overheating protection



The welding power source has overheating protection that operates if the internal temperature becomes too high. When this occurs the welding current is interrupted and an overheating symbol appears in the display (EMP), or the overtemperature indicator is illuminated (EM).



The overheating protection resets automatically when the temperature has returned to normal working temperature.

## 6 CONTROL PANEL

General safety regulations for handling the equipment can be found in the "SAFETY PRECAUTIONS" chapter of this manual. General information about operation can be found in the "OPERATION" chapter of this manual. Read both chapters thoroughly before you start using the equipment!

### 6.1 How to navigate - EMP 235ic

After power on has completed the main menu appears on the control panel.

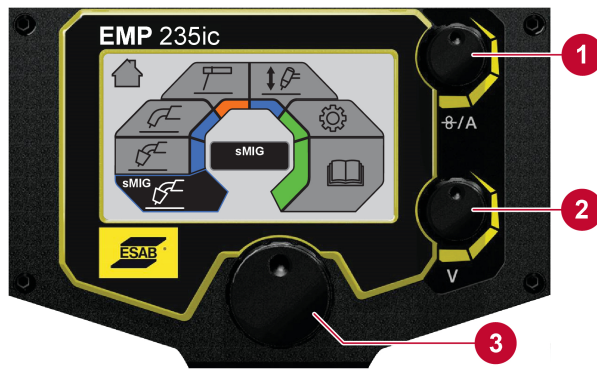

1. Current / Wire feed speed selection
2. Voltage selection
3. Menu navigation. Rotate and push to select menu option.

#### 6.1.1 Main menu

EMP 235ic

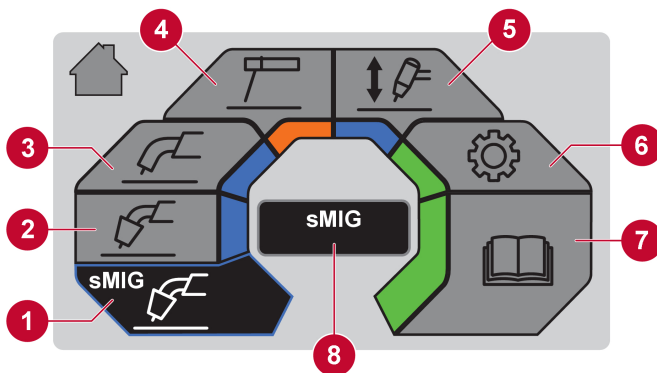

1. sMIG mode
2. Manual MIG mode
3. Flux cored wire mode
4. Stick/MMA mode
5. Lift-TIG mode
6. Settings
7. User manual information
8. Dialogue box

#### 6.1.2 sMIG mode

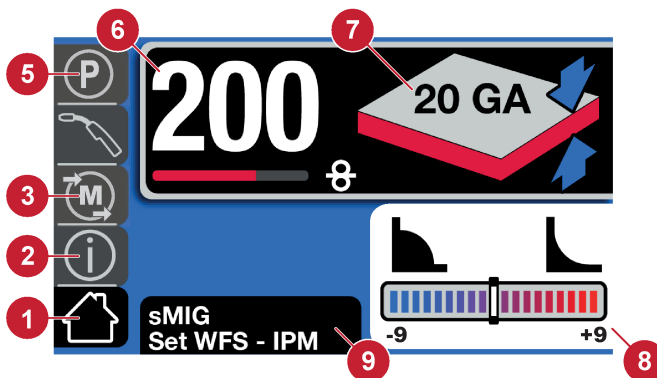

1. Home screen
2. Information
3. Memory
4. MIG/Spool gun selection
5. Parameter
6. Wire feed speed
7. Material thickness
8. Trim box
9. Dialogue box

### 6.1.3 Manual MIG mode

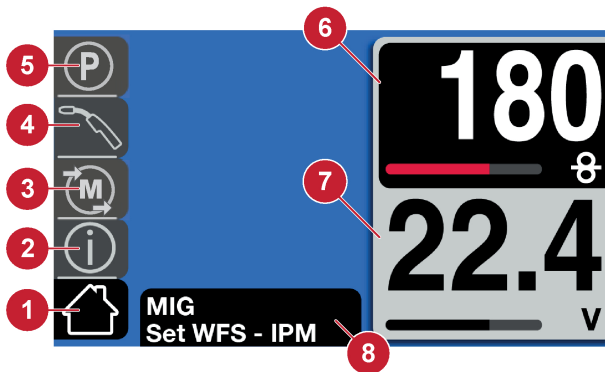

1. Home screen
2. Information
3. Memory
4. MIG/Spool gun selection
5. Parameter
6. Wire feed speed
7. Voltage
8. Dialogue box

### 6.1.4 Flux cored wire mode

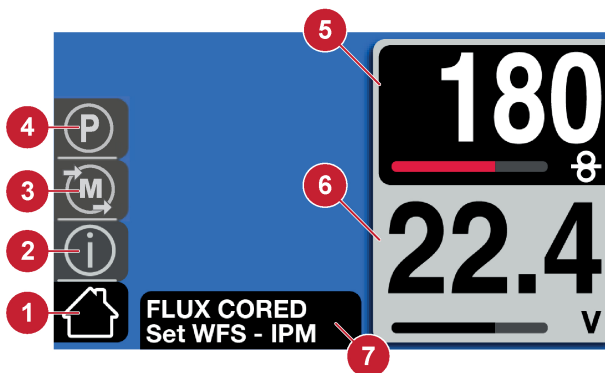

1. Home screen
2. Information
3. Memory
4. Parameter
5. Wire feed speed
6. Voltage
7. Dialogue box

### 6.1.5 Stick mode

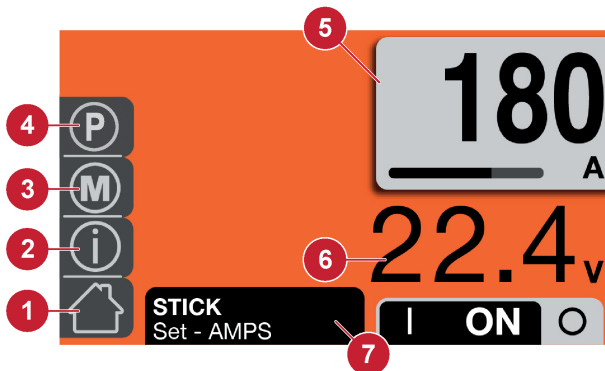

1. Home screen
2. Information
3. Memory
4. Parameter
5. Amperage
6. Voltage (OCV or arc)
7. Dialogue box

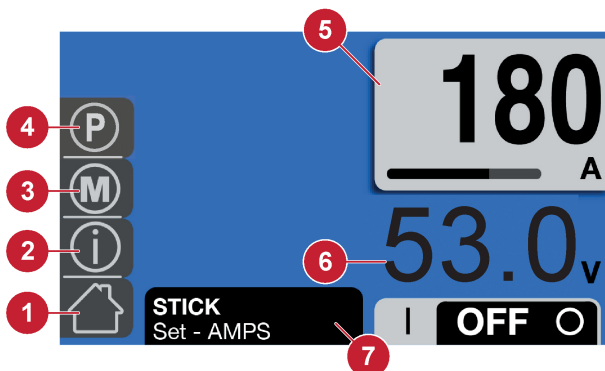

The user must select the ON position to have output voltage and weld current. Also the background color indicates the output state, where blue indicates an "off" state and orange indicates an "on" state.

### 6.1.6 LIFT-TIG mode (EMP 235ic only)

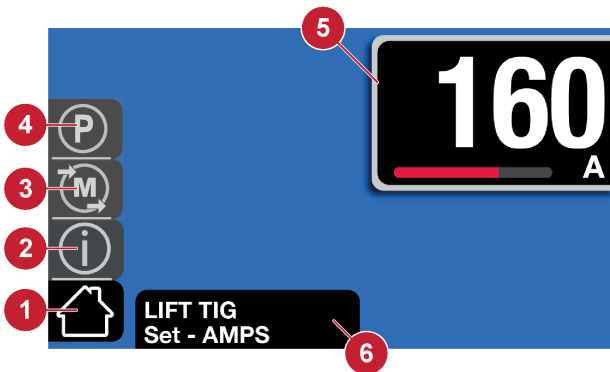

1. Home screen
2. Information
3. Memory
4. Parameter
5. Amperage
6. Dialogue box

### 6.1.7 Settings

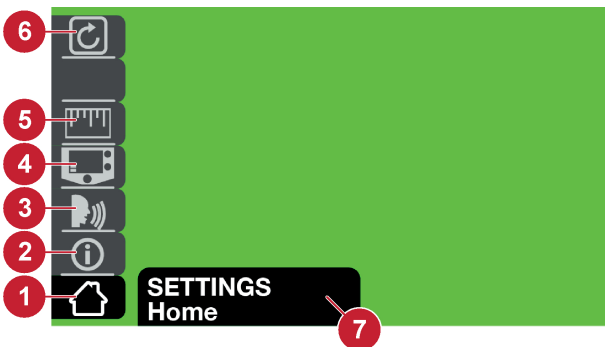



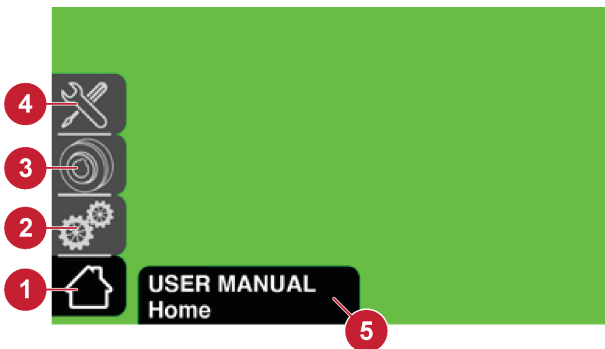

1. Home screen
2. Information
3. Language
4. Basic/Advanced
5. Inch/Metric
6. Reset mode
7. Dialogue box





















### 6.1.8 User manual information









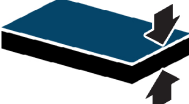











1. Home screen
2. Operation information
3. Wear & Spare parts
4. Maintenance information
5. Dialogue box

### 6.1.9 Icon reference guide

	Home		Spot time on/off selection
	Information		

	<b>MIG Gun</b>		<b>Spot time on adjustment</b>
	<b>Parameters</b>		<b>Flux cored</b>
	<b>Parameters</b>		<b>Manual MIG</b>
<b>%</b>	<b>Percent</b>		<b>Settings</b>
	<b>Prewflow</b> The time the shielding gas stays on before the welding arc is started		<b>Smart MIG</b>
	<b>Postflow</b> The time the shielding gas stays on after the welding arc is stopped		<b>Cancel</b>
<b>S</b>	<b>Seconds</b>		<b>Saving</b> welding programs for a specific application when in the Memory Mode
	<b>Settings</b> on user manual menu		<b>Burnback</b> Adjusting the time when the voltage stays on after the wire feed is stopped to keep the wire from freezing in the weld puddle
	<b>Spool Gun</b>		<b>Stick</b>
	<b>2T, Trigger On/OFF</b>		<b>Lift-TIG</b>
	<b>4T, Trigger Hold/Lock</b>		<b>User Manual</b> on main menu
<b>A</b>	<b>Amps</b>		<b>Plate thickness</b> at sMIG mode

	<p><b>Arc force</b> On stick welding-increasing amps when the arc length is shortened to reduce or eliminate the freezing of the stick electrode in the weld puddle</p>		<p><b>Trim bar</b> Changing the weld bead profile from flat to convex or flat to concave</p>
	<p><b>Downslope</b> Sloping the current down over a period of time at the end of the weld cycle</p>		<p><b>Bead profile, concave</b></p>
	<p><b>Hot start</b> The increase of amps when striking the electrode to reduce sticking</p>		<p><b>Bead profile, convex</b></p>
	<p><b>Inductance</b> The addition of inductance into the arc characteristics to stabilize the arc and reduce spatter when in the short circuit process</p>		<p><b>Advanced Settings</b></p>
	<p><b>Memory</b>, able to save welding programs for a specific application</p>		<p><b>Basic Settings</b></p>
	<p><b>Stick electrode choice</b></p>		<p><b>Diagnostics</b></p>
	<p><b>Upslope</b>, Sloping the current up over a period of time at the beginning of the weld cycle</p>		<p><b>Language selection</b></p>
	<p><b>Volts</b></p>		<p><b>Unit of Measure</b></p>
	<p><b>Wire feed speed</b></p>	<p>.030" (.8 mm)</p> 	<p><b>Wire diameter</b></p>

## 6.2 How to navigate - EM 235ic

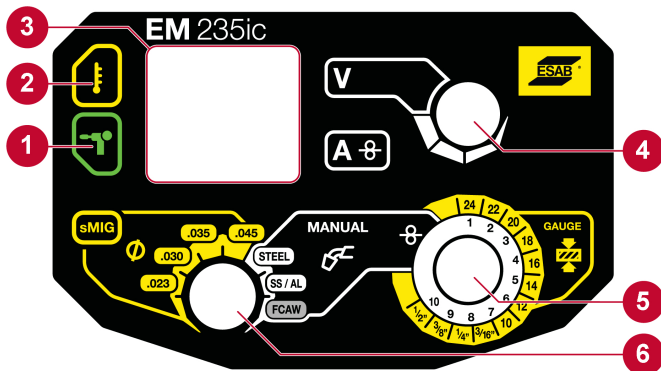

1. Spool gun indication: Symbol illuminates when spool gun is connected.
2. Over temperature indication: Symbol illuminates when product is overheated.
3. Volt/Amp display: LED displays the Volts and Amps values during welding. It holds the last used parameter. In sMIG "V" displays the wire diameter while idle "A" displays the set wire feed speed.
4. Voltage knob: Adjust the voltage value (in sMIG not functional).
5. Knob for plate thickness or wire feed speed: in sMIG mode (outer circle, in yellow) plate thickness can be adjusted. Wire feed speed can be adjusted when in manual MIG/MAG or flux cored (inner circle, in white).
6. Process selection knob: Enables selection between sMIG mode (left, in yellow) and manual MIG mode (right, in white).





**NOTE!**

Third-party spool guns cannot be used with the EM 235ic. The EM 235ic only operates with Rebel spool guns.

### 6.2.1 Symbol reference EM 235ic

	<b>Overtemperature</b>		<b>Volts</b> (manual MIG mode only)
	<b>Spool Gun</b>		<b>Amps</b>
	<b>Smart MIG</b>		<b>Wire feed speed</b>

6 CONTROL PANEL

	<p><b>Wire diameter</b> (sMIG mode only)</p>		<p><b>Thickness gauge</b> (sMIG mode only)</p>
<p>MANUAL</p> 	<p><b>Manual MIG</b></p>		

## 7 MAINTENANCE



### NOTE!

Regular maintenance is important for safe and reliable operation.



### CAUTION!

Only persons with the appropriate electrical knowledge (authorized personnel) may remove the cover of the product or carry out service, maintenance or repair work on the welding equipment.



### CAUTION!

The product is covered by manufacturer's warranty. Any attempt to carry out repair work by non-authorized service centers will invalidate the warranty.



### WARNING!

Disconnect power before performing maintenance. Maintain control and awareness of the disconnected power connections when performing work. Detect and prevent premature reconnection of the power.



### NOTE!





Perform maintenance more often during severe dusty conditions.

Before each use, make sure that the:

- The torch body and torch cable and leads are not damaged.
- The contact tip on the torch is not damaged.
- The nozzle on the torch is clean and does not contain any debris.

### 7.1 Routine maintenance

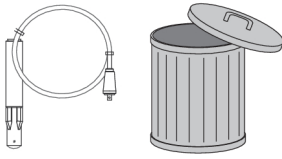
Maintenance schedule during normal conditions.

Interval	Area to maintain		
Every 3 months	 Clean or replace unreadable labels.	 Clean weld terminals.	 Check or replace weld cables.
Every 6 months	 Clean inside equipment.		

### 7.2 Power source and wire feeder maintenance

Perform a power source cleaning each time you replace a Ø4 in. (100 mm), Ø8 in. (200 mm) or Ø12 in. (300 mm) wire bobbin.

## Power source and wire feeder cleaning procedure



### NOTE!

Always wear safety gloves during cleaning.

1. Disconnect the power source from the mains socket.
2. Open the lid and release the tension from the pressure roller by turning the tension screw (1) counter-clockwise and then pull it toward you.
3. Remove the wire and the wire spool.
4. Remove the torch and use a low pressure airline, taking care not to let the wire consumable unravel, to clean the power source interior and power source air inlet and outlet.
5. Inspect if the inlet wire guide (4), outlet wire outlet (2) or the feeder roller (3) are worn and need replacement. See appendix WEAR PARTS for ordering numbers of parts.
6. Remove and clean the feeder roller with a soft brush. Clean the pressure roller attached to the wire feeder mechanism with a soft brush.

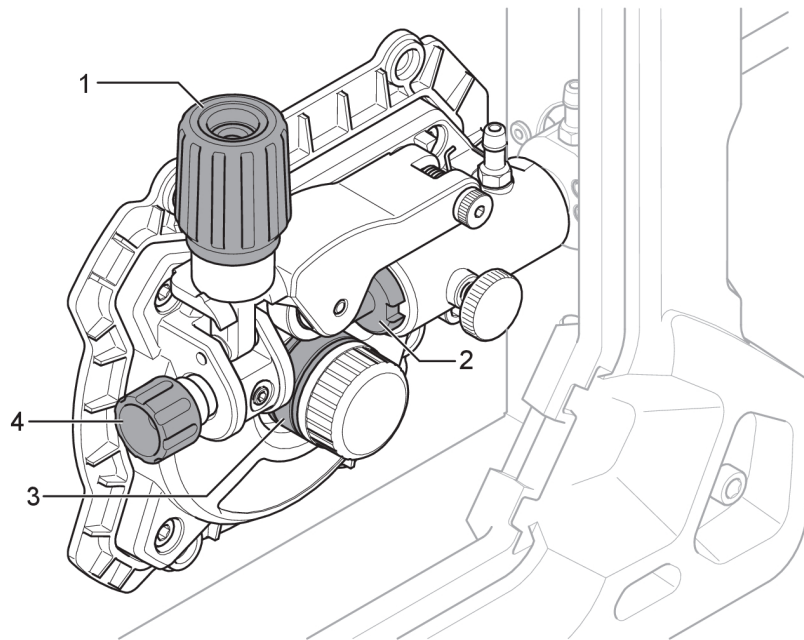

## 7.3 Torch and liner maintenance

### Torch and liner cleaning procedure

1. Disconnect the power source from the mains socket.
2. Open the lid and release the tension from the pressure roller by turning the tension screw (1) counter-clockwise and then pull it toward you.
3. Remove the wire and the wire spool.
4. Remove the torch from the power source.
5. Remove the liner from the torch and inspect it. Clean the liner by blowing compressed air (max. 5 bar) through the end of the liner that was mounted closest to the power source.
6. Re-install the liner.

## 8 TROUBLESHOOTING

Try these checks and inspections before sending for an authorized service technician.

Type of fault	Corrective action
Porosity within the weld metal	<ul style="list-style-type: none"> <li>• Check that the correct gas is connected and the correct gas flow is used.</li> <li>• Keep the distance between the MIG torch nozzle and the work piece to a minimum.</li> <li>• Make sure the work piece is clean before welding.</li> </ul>
Wire feeding problems See appendix WEAR PARTS for correct sizes and types.	<ul style="list-style-type: none"> <li>• Make sure the wire spool brake is adjusted correctly.</li> <li>• Make sure the feed roller is correct size and not worn.</li> <li>• Make sure the correct pressure on the feed rollers is set.</li> <li>• Make sure the correct contact tip is used and it is not worn.</li> <li>• Make sure the liner is not bent so that friction is caused between the liner and the wire.</li> </ul>
MIG (GMAW/FCAW) welding problems	<ul style="list-style-type: none"> <li>• Make sure the MIG torch is connected to correct polarity. Refer to the electrode wire manufacturer for the correct polarity.</li> <li>• Replace contact tip if it has arc marks in the bore causing excessive drag on the wire.</li> <li>• Make sure the correct shielding gas, gas flow, voltage, welding current, travel speed and MIG torch angle is used.</li> <li>• Make sure the work lead has proper contact with the work piece.</li> </ul>
STICK (SMAW) basic welding problems	<ul style="list-style-type: none"> <li>• Make sure you are using correct polarity. The electrode holder is usually connected to the positive polarity and the work lead to the negative polarity. If in doubt consult the electrode data sheet.</li> </ul>
TIG (GTAW) welding problems	<ul style="list-style-type: none"> <li>• Make sure the TIG torch is connected to the power source: Connect the TIG torch to the negative [-] welding terminal. Connect the welding ground cable to the positive [+] welding terminal.</li> <li>• Use only 100% Argon gas for TIG welding.</li> <li>• Make sure the regulator/flow meter is connected to the gas bottle.</li> <li>• Make sure the gas pipe for the TIG torch is connected to the gas outlet connector (M12) on the front of the power source.</li> <li>• Make sure the work clamp has proper contact with the work piece.</li> <li>• Make sure the gas bottle is opened and check the gas flow rate on the regulator/flow meter. The flow rate should be between 1.25–3.12 gpm (4.72–11.80 l/min).</li> <li>• Make sure the power source is turned on and TIG welding process is selected.</li> <li>• Make sure all connections are tight and leak-free.</li> </ul>

<b>Type of fault</b>	<b>Corrective action</b>
No arc	<ul style="list-style-type: none"><li>• Check that the mains power supply switch is turned on.</li><li>• Check that the mains, welding and return cables are correctly connected.</li><li>• Check that the correct current value is set.</li><li>• Check the mains power supply fuses.</li></ul>
The overheating protection trips frequently.	<ul style="list-style-type: none"><li>• Make sure that you are not exceeding the recommended duty cycle for the weld current you are using. See section "Duty cycle" in the OPERATION chapter.</li><li>• Make sure the air inlets or outlets are not clogged.</li></ul>

## 9 ORDERING SPARE PARTS

---



### CAUTION!

Repair and electrical work should be performed by an authorized ESAB service technician. Use only ESAB original spare and wear parts.

The EM 235ic and EMP 235ic are designed and tested in accordance with international standards **IEC 60974-1**, **IEC 60974-5**, Canadian and US standards **CAN/CSA-E60974-1:12** and US standards **ANSI/IEC 60974-1:2008**. It is the obligation of the authorized service center carrying out the service or repair work to ensure that the product still conforms to the aforementioned standards.

The spare parts list is published in a separate document that can be downloaded from the Internet: [www.esab.com](http://www.esab.com)

## MIG WELD PARAMETER CHART

120 VAC / 30A Electrical outlet through 1/4 in.

120 VAC / 20A Electrical outlet through 3/16 in.

120 VAC / 15A Electrical outlet through 1/8 in.

### 120 VAC

Material selection	Welding wire type	Shield gas	Material thickness	22 ga.	18 ga.	16 ga.	1/8 in.	3/16 in.	1/4 in.
Mild steel	ER70S-6 0.023 in. (0.6 mm)	75% Ar 25% CO <sup>2</sup>	Wire speed display	165	295	325	385	430	
			Voltage display	14.2	16.2	17	19.2	19.5	
			Inductance display	35%	35%	35%	35%	35%	
Mild steel	ER70S-6 0.030 in. (0.8 mm)	75% Ar 25% CO <sup>2</sup>	Wire speed display	86	129	153	232		
			Voltage display	15	17	17.5	19		
			Inductance display	35%	35%	35%	35%		
Mild steel	ER70S-6 0.035 in. (0.9 mm)	75% Ar 25% CO <sup>2</sup>	Wirespeed display	95	118	129	224		
			Voltage display	15	15.5	16.5	18.5		
			Inductance display	35%	35%	35%	35%		
Stainless steel	ER308L/ 316L 0.030 in. (0.8 mm)	90% He 7.5% Ar 2.5% CO <sup>2</sup>	Wire speed display	150	160	180	300	350	
			Voltage display	16.5	17	18.5	20	25	
			Inductance display	90%	90%	90%	90%	90%	
Mild steel	ER71T-11 0.030 in. (0.8 mm)	No gas required	Wire speed display		70	90	173	E71T-11 0.035 in. (0.9 mm)	
			Voltage display		14	14	16		
			Inductance display		0%	0%	0%		
Aluminum Use spool gun.	E4043 0.035 in. (0.9 mm)	100% Ar	Wire speed display		270	300	375		
			Voltage display		14.5	15.5	20		
			Inductance display		35%	35%	35%		

### 230 VAC

MIG WELD PARAMETER CHART

Material selection	Welding wire type	Shield gas	Material thickness	22 ga.	18 ga.	16 ga.	1/8 in.	3/16 in.	1/4 in.
Mild steel	ER70S-6 0.023 in. (0.6 mm)	75% Ar 25% CO <sup>2</sup>	Wire speed display	200	250	300	400		
			Voltage display	15	16	16	19		
			Inductance display	35%	35%	35%	35%		
Mild steel	ER70S-6 0.030 in. (0.8 mm)	75% Ar 25% CO <sup>2</sup>	Wire speed display		90	130	280	400	500
			Voltage display		14	15	16	18	19
			Inductance display		35%	35%	35%	35%	35%
Mild steel	ER70S-6 0.035 in. (0.9 mm)	75% Ar 25% CO <sup>2</sup>	Wire speed display		85	120	24	320	360
			Voltage display		15	15	17	18	19
			Inductance display		35%	35%	35%	35%	35%
Stainless steel	ER308L/ 316L 0.030 in. (0.8 mm)	90% He 7.5% Ar 2.5% CO <sup>2</sup>	Wire speed display			185	250		
			Voltage display			19.5	21		
			Inductance display			90%	90%		
Mild steel	ER71T-11 0.035 in. (0.9 mm)	No gas required	Wire speed display			80	170	360	
			Voltage display			15	17	17	
			Inductance display			0%	0%	0%	
Aluminium Use spool gun.	E4043 0.035 in. (0.9 mm)	100% Ar	Wire speed display				200	275	300
			Voltage display				23	24	25
			Inductance display				35%	35%	35%

# FRACTION TO DECIMAL CONVERSION

	$\frac{1}{64}$	0.015625
	$\frac{1}{32}$	0.03125
	$\frac{3}{64}$	0.046875
	$\frac{1}{16}$	0.0625
	$\frac{5}{64}$	0.078125
	$\frac{3}{32}$	0.093750
	$\frac{7}{64}$	0.109375
	$\frac{1}{8}$	0.125
	$\frac{9}{64}$	0.140625
	$\frac{5}{32}$	0.15625
	$\frac{11}{64}$	0.171875
	$\frac{3}{16}$	0.1875
	$\frac{13}{64}$	0.203125
	$\frac{7}{32}$	0.21875
	$\frac{15}{64}$	0.234375
	$\frac{1}{4}$	0.25
	$\frac{17}{64}$	0.265625
	$\frac{9}{32}$	0.28125
	$\frac{19}{64}$	0.296875
	$\frac{5}{16}$	0.3125
	$\frac{21}{64}$	0.328125
	$\frac{11}{32}$	0.34375
	$\frac{23}{64}$	0.359375
	$\frac{3}{8}$	0.375
	$\frac{25}{64}$	0.390625
	$\frac{13}{32}$	0.40625
	$\frac{27}{64}$	0.421875
	$\frac{7}{16}$	0.4375
	$\frac{29}{64}$	0.453125
	$\frac{15}{32}$	0.46875
	$\frac{31}{64}$	0.484375
	$\frac{1}{2}$	0.5
	$\frac{33}{64}$	0.515625
	$\frac{17}{32}$	0.53125
	$\frac{35}{64}$	0.546875
	$\frac{9}{16}$	0.5625
	$\frac{37}{64}$	0.578125
	$\frac{19}{32}$	0.59375
	$\frac{39}{64}$	0.609375
	$\frac{5}{8}$	0.625
	$\frac{41}{64}$	0.640625
	$\frac{21}{32}$	0.65625
	$\frac{43}{64}$	0.671875
	$\frac{11}{16}$	0.6875
	$\frac{45}{64}$	0.703125
	$\frac{23}{32}$	0.71875
	$\frac{47}{64}$	0.734375
	$\frac{3}{4}$	0.75
	$\frac{49}{64}$	0.765625
	$\frac{25}{32}$	0.78125
	$\frac{51}{64}$	0.796875
	$\frac{13}{16}$	0.8125
	$\frac{53}{64}$	0.828125
	$\frac{27}{32}$	0.84375
	$\frac{55}{64}$	0.859375
	$\frac{7}{8}$	0.875
	$\frac{57}{64}$	0.890625
	$\frac{29}{32}$	0.90625
	$\frac{59}{64}$	0.921875
	$\frac{15}{16}$	0.9375
	$\frac{61}{64}$	0.953125
	$\frac{31}{32}$	0.96875
	$\frac{63}{64}$	0.984375
$\frac{1}{1}$	1	1

# DIAGRAM

EM 235ic, EMP 235ic

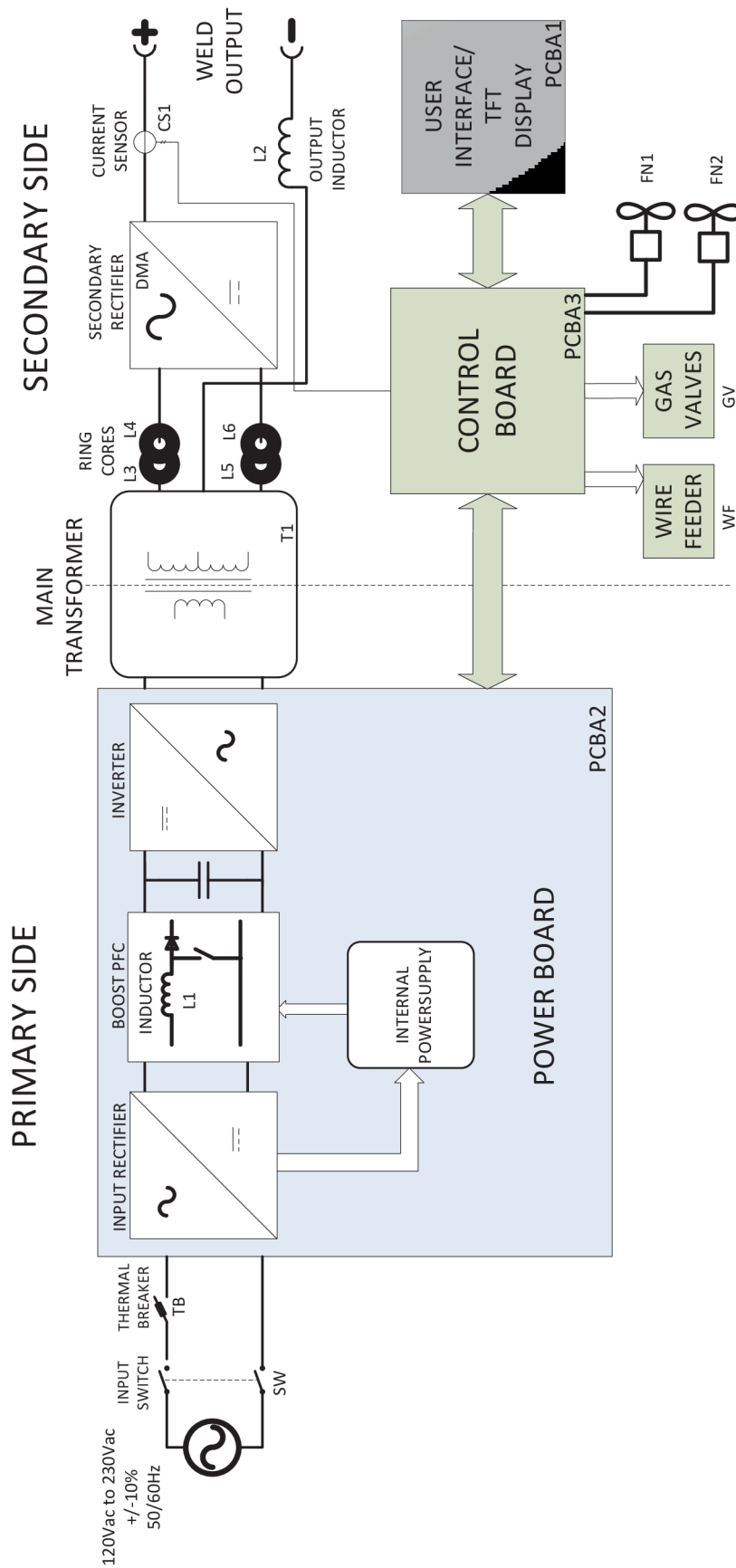

---

**ORDERING NUMBERS**

---



Ordering no.	Denomination	Note
0558 012 702	Rebel EMP 235ic	
0558 012 704	Rebel EMP 235ic with cart	
0558 012 700	Rebel EM 235ic	
0558 012 701	Rebel EM 235ic with cart	
0558 012 702MX	Rebel EMP 235ic MX	
0558 012 700MX	Rebel EM 235ic MX	
0463 485 001	Spare parts list	

---

**WEAR PARTS**

---

Item	Ordering no.	Denomination	Wire type	Wire dimensions
1	0558 102 515	Brass outlet assembly	N/A	N/A
2	0558 102 516	Wire outlet guide	Fe/SS/Flux Cored	0.024 in. / 0.030 in. (0.6 mm / 0.8 mm)
	0558 102 517	Wire outlet guide	Fe/SS/Flux Cored	0.035 in. / 0.052 in. (0.9 mm / 1.3 mm)
3	0558 102 328	Wire inlet guide	Fe/SS/Flux Cored	0.024 in. / 0.030 in. / 0.035 in. / 0.045 in. (0.6 mm / 0.8 mm / 0.9 mm / 1.2 mm)
4	0558 102 457	Crescent Woodruff key	N/A	N/A
5	7977036	Feed roll "V" groove	Fe/SS	0.024 in. / 0.030 in. (0.6 mm / 0.8 mm)
	7977660	Feed roll "V" groove	Fe/SS	0.035 in. / 0.045 in. (0.9 mm / 1.2 mm)
	7977732	Feed roll "V" knurled	Flux Cored	0.030 in. / 0.035 in. (0.8 mm / 0.9 mm)
	704277	Feed roll "V" knurled	Flux Cored	0.045 in. (1.2 mm)
	7977731	Feed roll "U"	Alum	0.030 in. / 0.035 in. (0.8 mm / 0.9 mm)
	7977264	Feed roll "U"	Alum	0.040 in. / 3/64 in. (1.0 mm / 1.2 mm)
6	0558 102 518	Locking knob	N/A	N/A
7	0558 102 329	Wire tension knob	N/A	N/A
8	0558 102 331	Pressure arm complete assembly	N/A	N/A
9	0558 102 550	Shoulder screw	N/A	N/A
10	0558 102 333	MIG torch locking knob	N/A	N/A

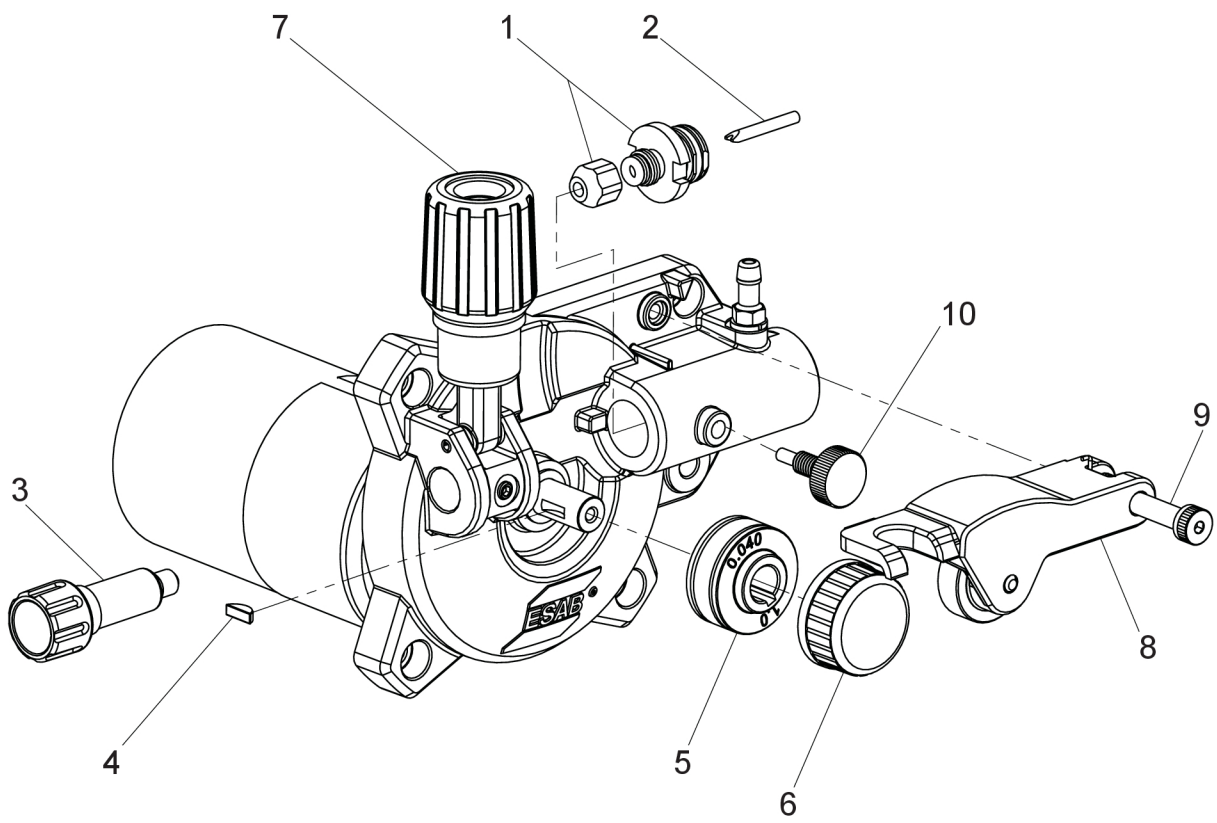

---

**ACCESSORIES**

---

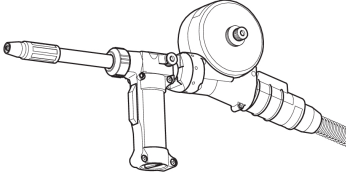
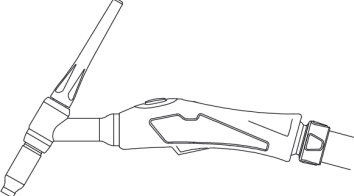
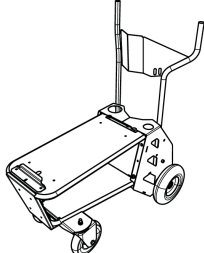
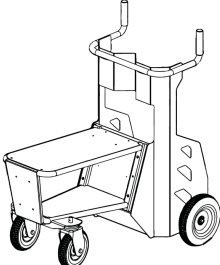
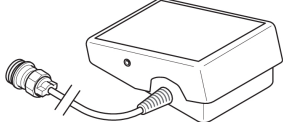
10271398	<b>Spool gun (CSA only)</b> 200 A, 12 ft (3.6 m), suits 4 in. (100 mm) spools	
0558102493	<b>TIG Torch (for EMP only)</b> TXH 201 5/8 in. npt 12.5 ft (3.5 m) TIG Torch Outfit	
0558102491	<b>Rebel Single Cylinder Cart</b> Accommodates maximum 9 in. (228.6 mm) diameter cylinder	
0558102492	<b>Rebel Dual Cylinder Cart</b> Accommodates 2 × 9 in. (228.6 mm) diameter cylinders	
W4014450	<b>Foot control</b> Contactor on/off and current control with 15 ft (4.6 m) cable and 8-pin male plug	

---

## REPLACEMENTS PARTS

---

**EMP series**

Item	Ordering no.	Denomination
1	10231140	Tweco® Spray Master 250 A MIG Gun 15 ft (4.5 m)
2	WS200E13	ESAB Stick electrode holder, 12 ft (4 m), 200 A
3	WS200G10	Ground clamp, 10 ft (3 m), 250 A
4	W4014000	Power adapter cable 230 V to 120 V, 15 A
5	07813657	Victor® Flow Meter with 10 ft (3 m) gas hose
6	V215B4045	Tweco® Classic Velocity™ No. 2 with 15.0 ft (4.6 m) cable
7	354TA8	Adapter cable 4 pin to 8 pin

**EM series**

Item	Ordering no.	Denomination
1	10231140	Tweco® Spray Master 250 A MIG Gun 15 ft (4.5 m)
2	WS200G10	Ground clamp, 10 ft (3 m), 250 A
3	W4014000	Power adapter cable 230 V to 120 V, 15 A
4	07813657	Victor® Flow Meter with 10 ft (3 m) gas hose
5	V215B4045	Tweco® Classic Velocity™ No. 2 with 15.0 ft (4.6 m) cable
6	354TA8	Adapter cable 4 pin to 8 pin





# A WORLD OF PRODUCTS AND SOLUTIONS.



For contact information visit [esab.com](http://esab.com)

ESAB AB, Lindholmsallén 9, Box 8004, 402 77 Gothenburg, Sweden, Phone +46 (0) 31 50 90 00

[manuals.esab.com](http://manuals.esab.com)

